

aura  
design

[www.auraadesign.co.uk](http://www.auraadesign.co.uk)

TRENDY

TRENDY





## Trendy desk worktops

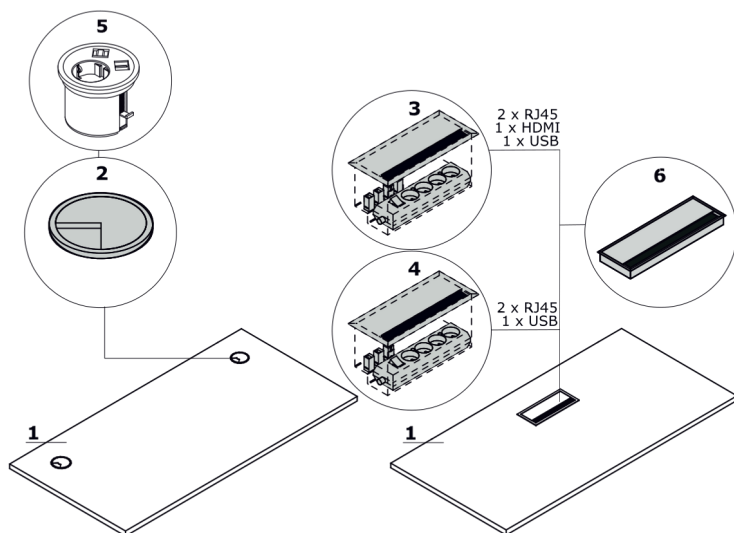

**1. Worktop** - MFC 28 mm, ABS edge

**OPTIONS WITH EXTRA CHARGE:**

**2. Grommet** - 2 pcs, Ø 80 mm

**3. Mediabox** - 2 x RJ45 (class E, cat. 6); + 1 x USB + 1 x HDMI + 4 x 230V

**4. Mediabox** - 2 x RJ45 (class E, cat. 6); + 1 x USB + 4 x 230V

**5. Mediabox** - 1 x 230V + 1 x USB charger + 1 x RJ45, colour: black, white, mounted instead of the existing grommet Ø80 mm

**6. Top access**

**7. Cable way** - the width of the opening is proportional to the width of the worktop

**8. Mediabox + cable grommets**

**9. Cable way + cable grommets** - desks, bench desks

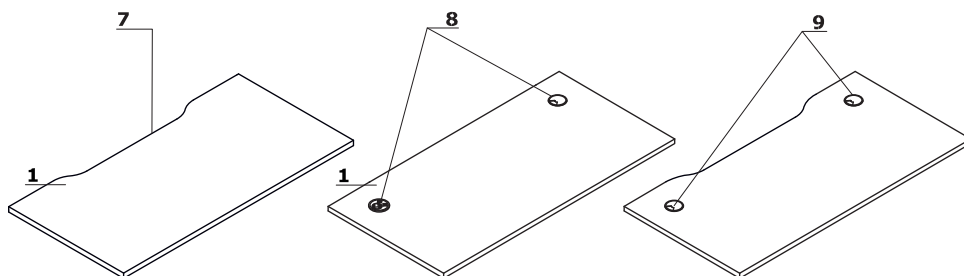

## Frame

**Trendy:** natural wood - ash, coated with transparent varnish, with metal element, powder coated, profile 40 × 40 mm, spacer 10 mm between top and frame

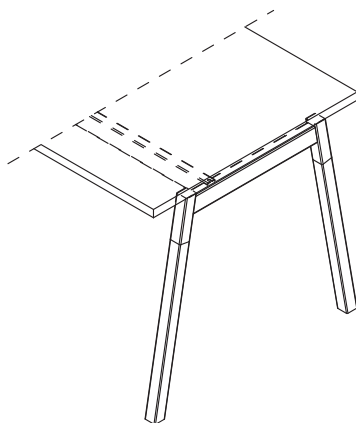

Attention - cable tray under the worktop is always – aluminium semi-matt colour.  
Attention - leveling - 10 mm range.

## Accessories

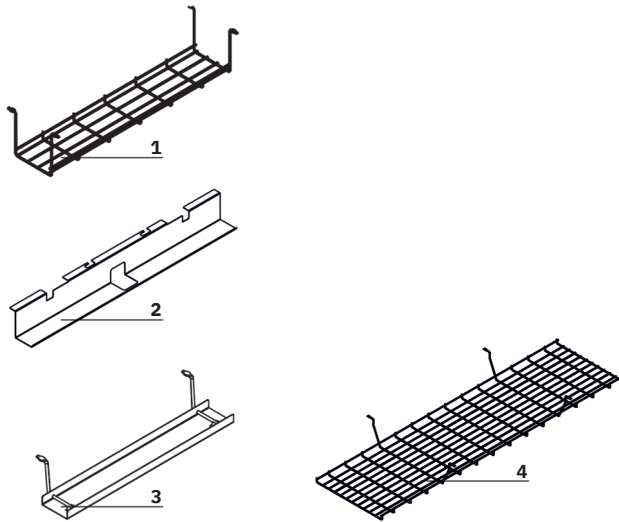

1. Horizontal cable tray - powder coated
2. Single desk horizontal cable tray - powder coated metal
3. Horizontal cable tray E64 - powder coated
4. Cable tray for bench desks - steel wire Ø4 mm, powder coated

## Sliding top

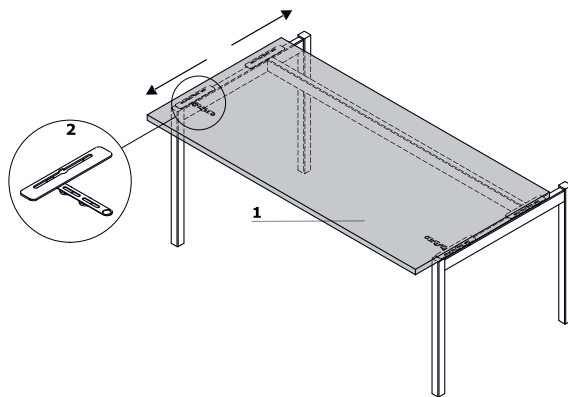

1. Sliding top - shifting range 141 mm
2. Tabletop sliding lock

Note – mediaboxes cannot be installed.

## Power strip - for series connection

1. set for 1 workstation - power strip (3x SCHUCKO, 2x RJ45) x1 + power cord (universal outlet PL/FR/Schucko)
2. set for 2 workstation - power strip (3x SCHUCKO, 2x RJ45) x2 + set of power cords (universal outlet PL/FR/Schucko)
3. set for 3 workstation - power strip (3x SCHUCKO, 2x RJ45) x3 + set of power cords (universal outlet PL/FR/Schucko)

1

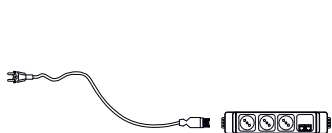

2

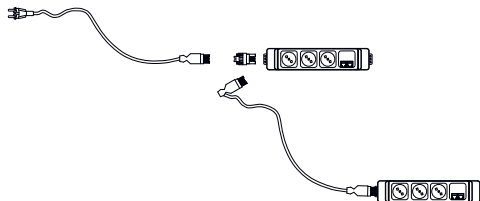

3

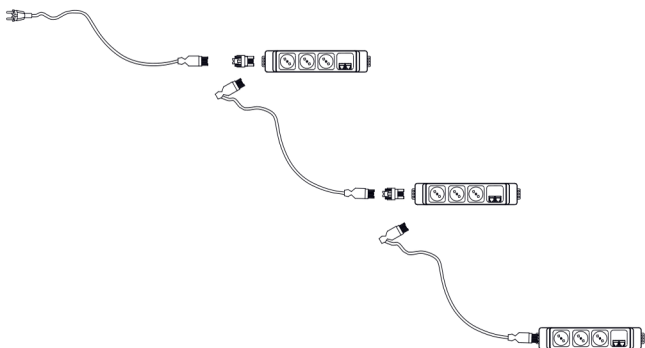

## Elements for desks pairing

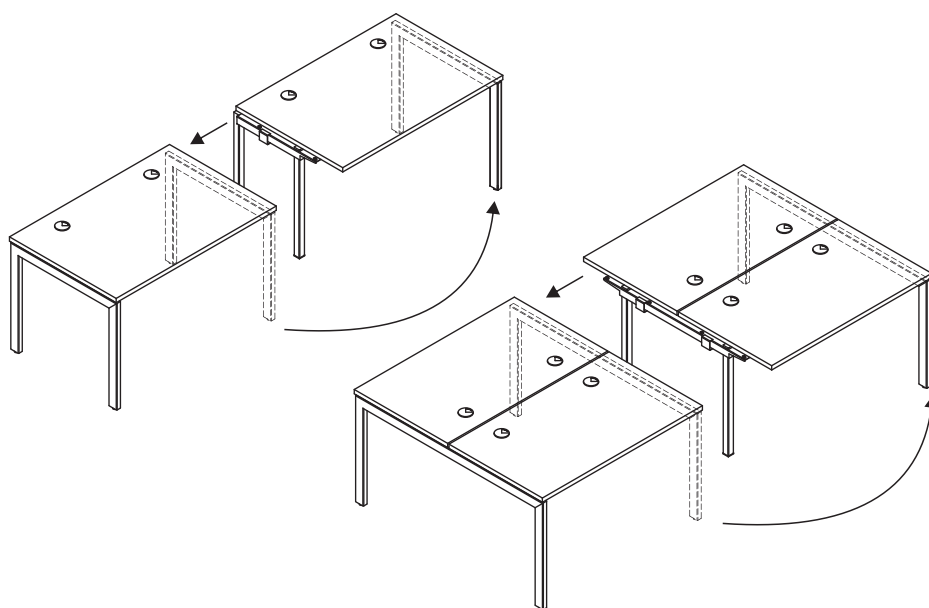

# TRENDY

## Desks \*



1000 / 600 / 740  
23.4 kg



1200 / 600 / 740  
25.3 kg



1400 / 600 / 740  
48 kg



1600 / 600 / 740  
31.5 kg



1000 / 700 / 740  
26.05 kg



1200 / 700 / 740  
31.7 kg



1400 / 700 / 740  
57.8 kg



1600 / 700 / 740  
39.5 kg



1200 / 800 / 740  
34 kg



1400 / 800 / 740  
36.75 kg



1600 / 800 / 740  
41.05 kg



1800 / 800 / 740  
45.55 kg

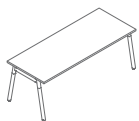

2000 / 800 / 740  
48.6 kg



1000 / 1000 / 740  
90.85 kg

## Elements for arrangement building - straight desk, natural wood \*

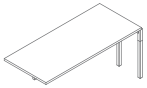

1200 / 700 / 740  
28.45 kg

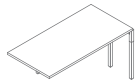

1400 / 700 / 740  
29.55 kg

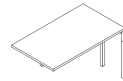

1600 / 700 / 740  
36.25 kg

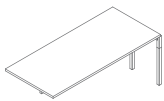

1200 / 800 / 740  
30.04 kg

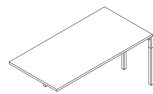

1400 / 800 / 740  
32.79 kg

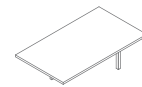

1600 / 800 / 740  
37.09 kg

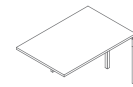

1800 / 800 / 740  
41.59 kg

## Bench desks \*



1000 / 1210 / 740  
41.8 kg

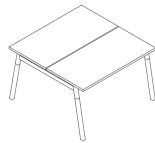

1200 / 1210 / 740  
45.6 kg



1400 / 1210 / 740  
59.1 kg

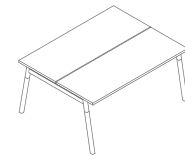

1600 / 1210 / 740 58  
kg

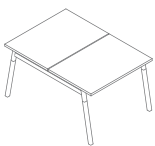

1000 / 1410 / 740  
48.1 kg

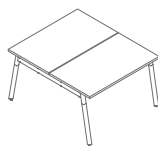

1200 / 1410 / 740  
59.4 kg



1400 / 1410 / 740  
61.6 kg



1600 / 1410 / 740  
75 kg

## Bench desks \*

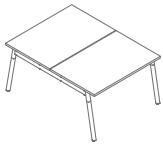

1200 / 1610 / 740  
63 kg

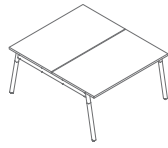

1400 / 1610 / 740  
68.5 kg

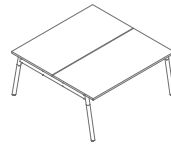

1600 / 1610 / 740  
77.1 kg

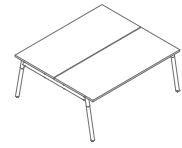

1800 / 1610 / 740  
86.1 kg

## Elements for arrangement building - bench, natural wood \*

\*

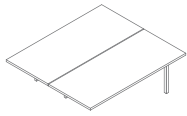

1200 / 1410 / 740  
53.78 kg

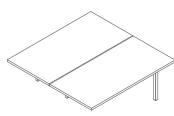

1400 / 1410 / 740  
55.98 kg

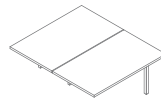

1600 / 1410 / 740  
69.38 kg

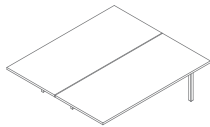

1200 / 1610 / 740  
56.96 kg

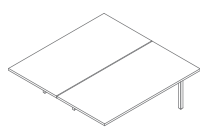

1400 / 1610 / 740  
62.46 kg

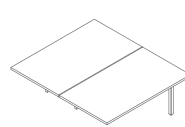

1600 / 1610 / 740  
71.06 kg

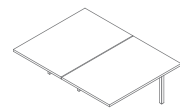

1800 / 1610 / 740  
80.06 kg



## Desk extensions \*



600 / 800 / 740  
15.05 kg



600 / 1000 / 740  
18.8 kg

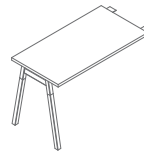

600 / 1200 / 740  
19.4 kg

---

## Power strip \*



500 / 430 / 569  
1.1 kg



500 / 430 / 569  
1.6 kg

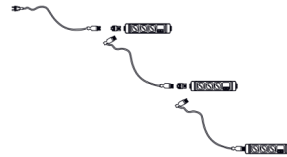

500 / 430 / 569  
2.1 kg

## Worktop, top, base, body, front



Aluminum satinato



Canadian oak

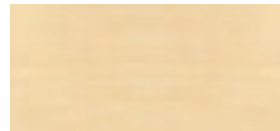

Polar birch



Cocoa



Natural oak



Honey oak



Acacia



White pastel



Dark walnut

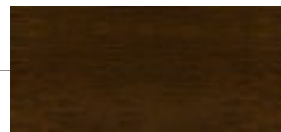

Lowland walnut



Anthracite



Black



Grey oak

## Base



Natural ash

## Grommets



Grey



Black



Beige



White pastel

## Accessories



Aluminum semi-matt



White semi-matt



Black semi-matt

# aura design



Hub Spaces, 582 Honeypot Lane, Stanmore, HA7 1JS, UK  
[www.auradesign.co.uk](http://www.auradesign.co.uk)  
020 3915 8008  
[info@auradesign.co.uk](mailto:info@auradesign.co.uk)