

auraa
design

www.auraadesign.co.uk

SOLERA

SOLERA



SOLERA

Meeting tables Solera

- 1. Worktop - MFC 28 mm, ABS edge
- 2. Leg - powder coated steel, profile 60x30 mm
- 3. Leveling - 5 mm range
- OPTIONS WITH EXTRA CHARGE:**
- 4. Top access
- 5. Mediabox - 2xRJ45 (class E, cat. 6); +1 x USB + 1 x HDMI + 4x 230V
- 6. Mediabox - 2xRJ45 (class E, cat. 6); +1 x USB + 4x 230V
- 7. Mediabox - OPTION WITH ADDITIONAL CHARGE
2x230V+HDMI+USB, colour: anodised aluminium, white, black

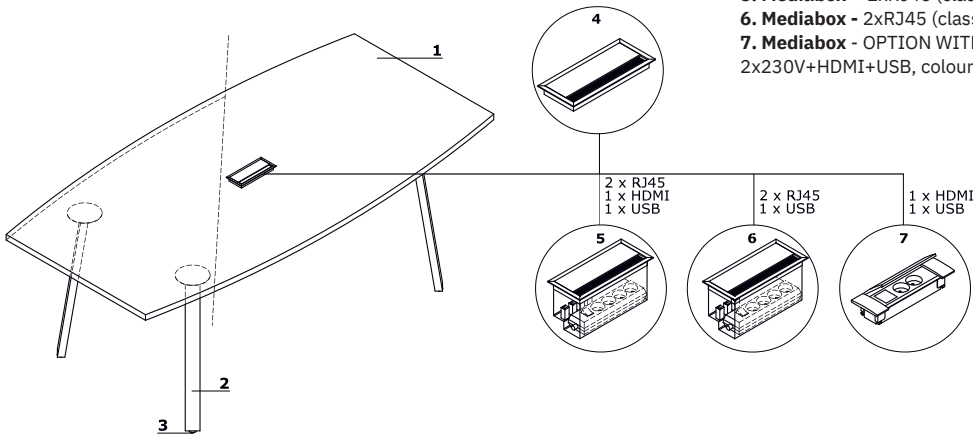

Mediabox location

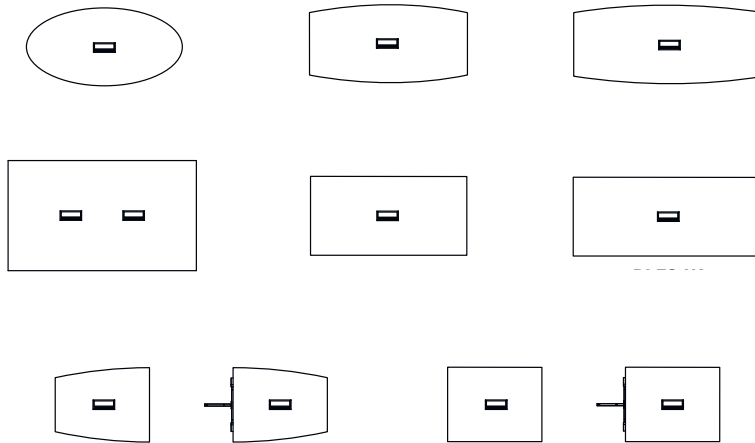

Chairs arrangement

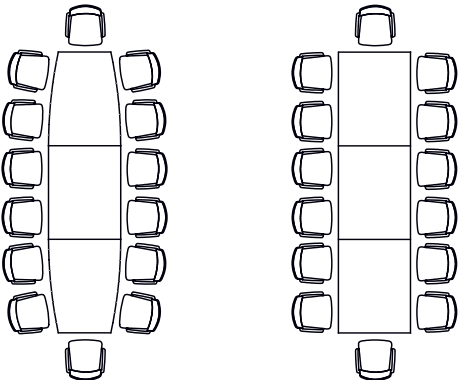
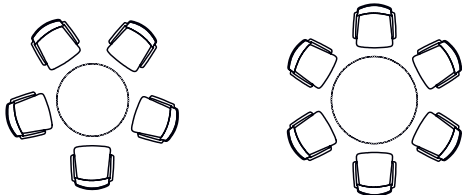
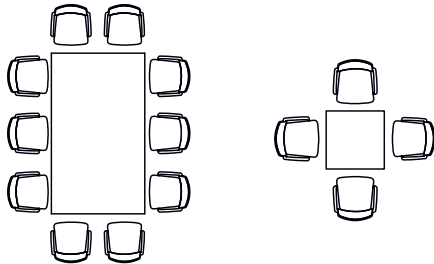
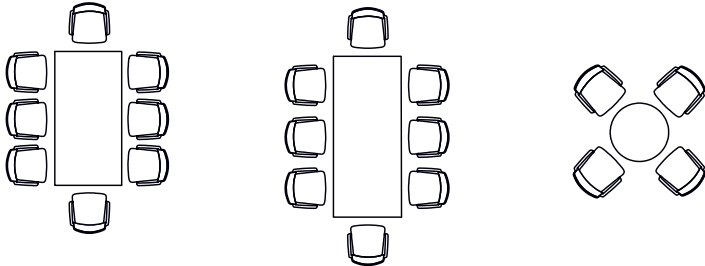
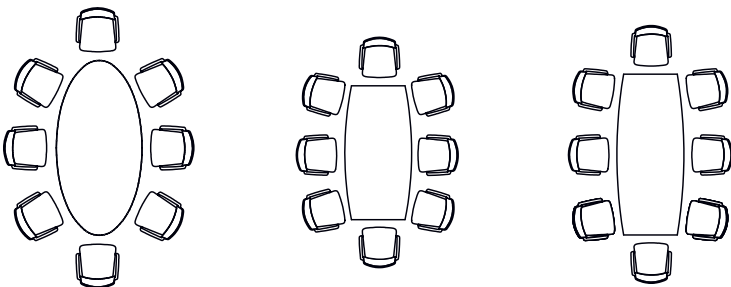

SOLERA

Meeting tables Solera *



800 / 800 / 740
17.1 kg



1000 / 1000 / 740
25 kg



1200 / 1200 / 740
33 kg

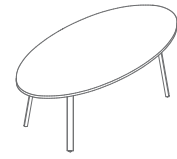

2000 / 1000 / 740
42 kg

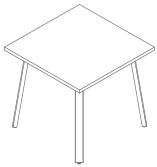

800 / 800 / 740
21.5 kg

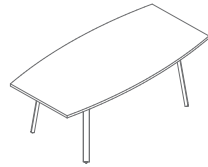

2000 / 800-1000 / 740
46.5 kg

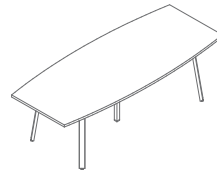

2400 / 800-1000 / 740
58.3 kg

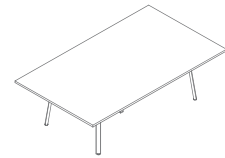

2400 / 1400 / 740
81 kg



1400 / 800-1100 / 740
45 kg



1400 / 1100 / 740
43 kg



1400 / 800-1100 / 740
33.5 kg

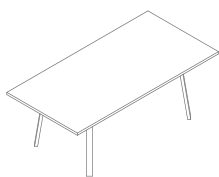

2000 / 1000 / 740
48.75 kg

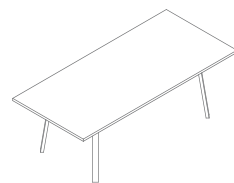

2400 / 1000 / 740
56.9 kg



1400 / 1100 /
740 47.9 kg



1400 / 1100 /
740 36.4 kg

* dimensions expressed in millimetres: width x depth x height

SOLERA

Meeting tables Solera *

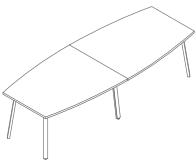

2800 / 1100-800 / 740
78.5 kg

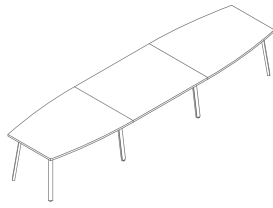

4200 / 1100*800 / 740
121.5 kg

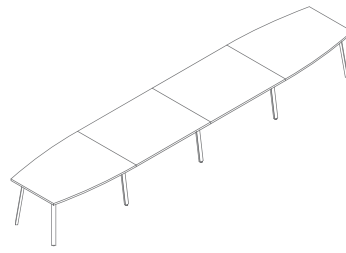

5600 / 1100-800 / 740
164.5 kg

Low tables Solera *



800 / 800 / 550
15.6 kg



600 / 600 / 550
11.5 kg

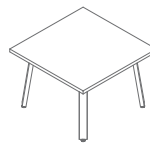

800 / 800 / 550
19.5 kg

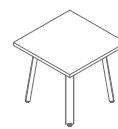

600 / 600 / 550
14 kg

www.auradesign.co.uk



1200 / 700 / 550
24.05 kg

Accessories *

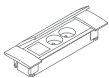

245 / 80 / 50
1 kg

* dimensions expressed in millimetres: width x depth x height

Top



Black



Aluminum satinato



Canadian oak



Polar birch



Cocoa



White pastel



Lowland walnut



Anthracite



Grey oak



Natural oak



Honey oak



Acacia



Dark walnut

www.auraaadesign.co.uk

Frame, mediabox



Aluminum semi-mat



White semi-mat



Anthracite semi-mat



Black semi-mat

aura design



Hub Spaces, 582 Honeypot Lane, Stanmore, HA7 1JS, UK
www.auraadesign.co.uk
020 3915 8008
info@auraadesign.co.uk