

RABANI

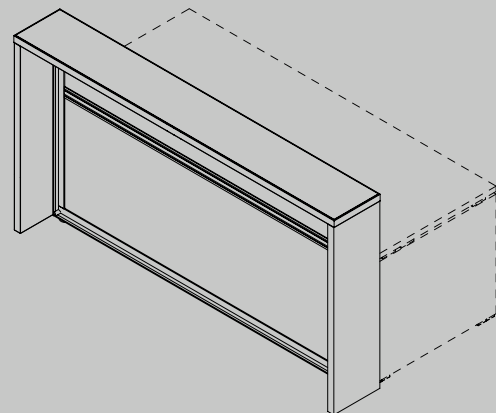

reception | receptions | accueils | recepciones



Rabani 1

Rabani arreda la zona ricevimento con soluzioni luminose e colorate, combinando tra loro tre elementi strutturali: una paretina frontale con telaio alluminio e riempimento in acrilico, tessuto o legno - i pannelli laterali lignei - un top reception in vetro retrolaccato con profilo in alluminio spazzolato lucido oppure in finitura legno. La reception Rabani si abbina ai tavoli di tutte le collezioni Auraa Design.

Rabani furnishes the reception area with bright colourful solutions, which include three structural elements: a front wall with an aluminium frame and a filler panel in acrylic, fabric or wood - chipboard side panels - and a reception top in back-lacquered glass with aluminium profile with polished brushed finish or wood finish. The Rabani reception counter can be matched with all Auraa Design work desk collections.

Rabani décore la zone accueil avec des solutions lumineuses et colorées, en associant entre eux trois éléments de structure: - un panneau avant avec cadre aluminium et habillage en acrylique, en tissu ou en bois, - des panneaux latéraux en bois - un plateau supérieur en verre rétro laqué avec profil en aluminium brossé brillant ou bien en finition bois. La banque d'accueil Rabani est disponible avec des finitions assorties aux plateaux de toutes les collections Auraa Design.

Rabani bietet für den Empfangsbereich leuchtende und farbenfrohe Einrichtungslösungen, die sich aus drei verschiedenen Strukturelementen zusammensetzen: einem Frontpaneel mit Aluminiumrahmen und Füllung aus Acryl, Stoff oder Holz - seitlichen Paneelen aus Holz - einer Rezeptionsplatte aus rückseitig lackiertem Glas mit Profil aus glänzendem gebürstetem Aluminium oder in Holz Ausführung. Das Rezeptionspult Rabani kann mit allen Tischen der Kollektionen Auraa Design kombiniert werden.

Rabani decora la zona de recepción con luminosas soluciones de colores que combinan tres elementos estructurales: una pared frontal con marco de aluminio y relleno de acrílico, tejido o madera, los paneles laterales de madera y una encimera de cristal retrolacado con perfil de aluminio cepillado brillante o en acabado madera. El banco de recepción Rabani puede combinarse con las mesas de todas las colecciones.



Rabani 1

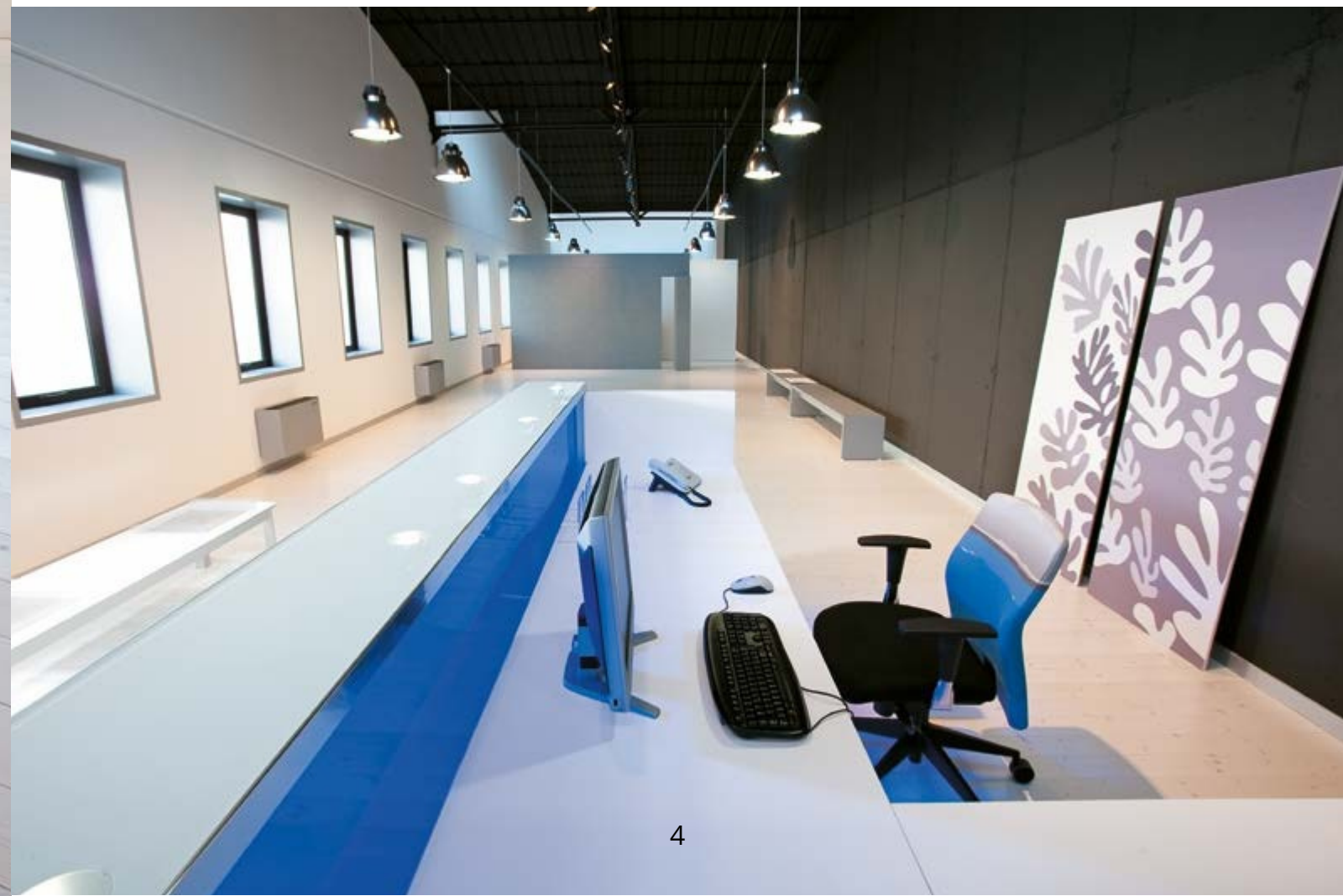



Rabani 1



Rabani 1

Gli elementi costitutivi sono modulari e facilmente adattabili. La struttura di Rabani è autoportante e indipendente dal tavolo lavoro. I pannelli lignei laterali sono dotati di profilo metallico dove agganciare utili accessori quali mensole, portacarte e portadocumenti.

All components are modular and adapt easily. The structure of Rabani is self-supporting and separate from the work desk. Its chipboard side panels are equipped with a metal profile, where useful accessories can be attached, such as shelves, paper trays and document trays.

Les éléments composants la banque d'accueil sont modulaires et facilement intégrables. La structure de Rabani est autoportante et donc indépendante du plan de bureau. Les panneaux latéraux en bois sont dotés d'un profil métallique sur lequel on peut accrocher des accessoires comme des étagères, des range-dossiers et des range-documents.

Die Bauelemente sind modular und daher mühelos einsetzbar. Die Struktur von Rabani ist selbsttragend und völlig unabhängig von den Arbeitstischen. Die seitlichen Paneele aus Holz sind mit Metallprofilen ausgestattet, in die nützliche Zubehörteile wie Borde, Aktenablagen und Stifthalter eingehakt werden können.

Los elementos que lo constituyen son modulares y fáciles de adaptar. La estructura de Rabani es autoportante e independiente de la mesa de trabajo. Los paneles de madera laterales están dotados de un perfil metálico donde pueden engancharse útiles accesorios como baldas, portapapeles y portadocumentos.

Rabani 1



Rabani 1



11



12

Rabani 1



Rabani 1



Mensola | Top | Support | Estante

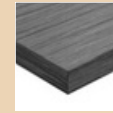

Senza profilo - melaminico
Without profile - Italian melamine
Sans profil - mélaminé
Sin perfil - melaminico

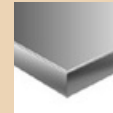

Con profilo - vetro
With profile - glass
Avec profil - verre
Con perfil - vidrio

Pannello frontale | Frontal panel | Panneau frontal | Panel frontal

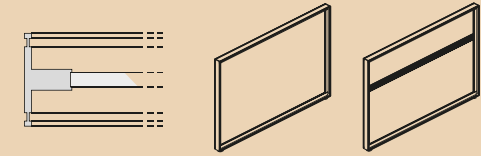

La parte frontale della reception è caratterizzata da un telaio in alluminio con sezione a "T" e pannelli in melaminico, goffrato, tessuto o metacrilato anche retrolaccato
The front of the reception desk features a T section aluminium frame with panels in different finishes: Italian melamine, embossed, fabric or acrylic (also backpainted)
La partie frontale de la réception est caractérisée par un châssis en aluminium avec section en "T" et panneaux disponibles en mélaminé, gaufré, tissu ou méthacrylate (également rétro-laqué)
La parte frontal del mueble de recepción está caracterizada por un marco de aluminio de sección en "T" y paneles disponibles en melaminico, lacado, tejido o metacrilato (también lacado por detrás)

Es. composizioni | Composition ex. | Ex. de compositions | Ej. de composiciones

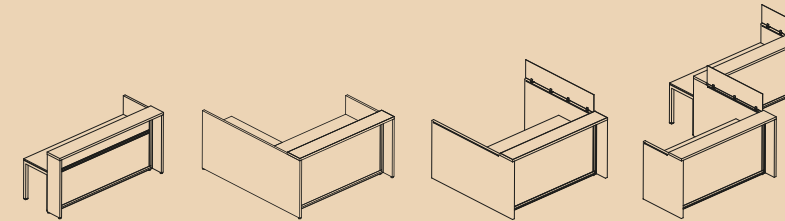









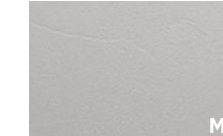
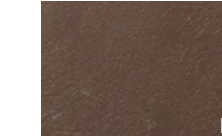

Finiture | Finishes | Finitions | Acabados

MEL

Melaminico

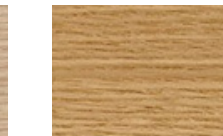
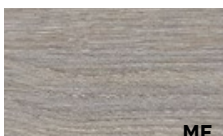
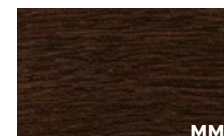
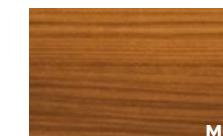
Melamine | Mélaminé | Melaminico

 Bianco rigato Rippled effect white Blanc avec rayures en sérigraphie Blanco rayado	 Grigio rigato Rippled effect grey Gris avec rayures en sérigraphie Gris rayado	 Nichel White Nickel Niquel	 Cacao Cocoa Cacao Cacao	 Bianco White Blanc Blanco
 Talco Talco Talco Talco	 Ocra Ochre Ocre Ocre	 Safari Safari Safari Safari	 Noisette Noisette Noisette Noisette	 Verde Green Vert Verde
 Nero Black Noir Negro	 Blu notte Night blue Bleu nuit Azul noche	 Ardesia Ardesia Ardesia Pizarra	 Rovere chiaro Light oak Chêne clair Roble claro	 Rovere americano American oak Chêne américain Roble americano
 Rovere grigio Grey oak Chêne gris Roble gris	 Rovere moro Dark oak Chêne foncé Roble oscuro	 Noce Canaletto Canaletto Walnut Noyer Canaletto Nogal Canaletto	 Noce scuro Dark walnut Noyer foncé Nogal oscuro	

GRES

Gres porcellanato

Porcelain tiles | Grès cérame | Gres porcelánico

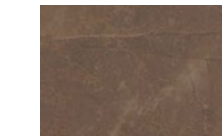
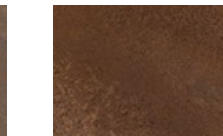
 Nero Black Noir Negro	 Basalt Basalt Basalt Basalt	 Calacatta Calacatta Calacatta Calacatta	 Pulpis Pulpis Pulpis Pulpis	 Corten Corten Corten Corten
--	--	--	---	--

TOP

GOF

Metacrilato retrolaccato









Backpainted acrylic | Méthacrylate rétro-laqué | Metacrilato retrolacado

 Bianco White Blanc Blanco	 Argento Silver Argent Plata	 Grigio scuro Dark grey Gris foncé Gris oscuro	 Noisette Noisette Noisette Noisette	 Ardesia Ardesia Ardesia Pizarra
 Moka Mocha Moka Cafe	 Nero Black Noir Negro	 Arancione Orange Orange Naranja	 Rosso "F" Red "F" Rouge "F" Rojo "F"	 Rubino Ruby Rubis Rubi
 Indaco Indigo Indigo Azul Indigo	 Azzurro Blue Bleu Azul	 Verde Green Vert Verde	 Cedro Lime green Vert Cédrot Verde Cedro	

TES

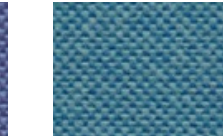
Tessuto

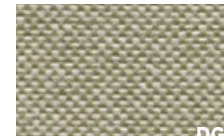
Fabric | Tissu | Tejido

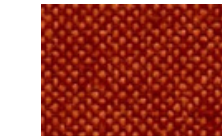
 Beige Beige Beige Beige	 Grigio chiaro Light grey Gris clair Gris claro	 Ardesia Ardesia Ardesia Pizarra	 Blu avio Avio blue Bleu avio Azul avio	 Acquamarina Aquamarine Aigue-marine Aguamarina
 Verde primavera Spring green Vert printemps Verde primavera	 Salvia Sage Sauge Salvia	 Arancio Orange Orange Naranja	 Corallo Coral Corail Coral	

VTR

Vetro (anche antimpronta NFG)

Glass (also antifinger NFG) | Verre (également antitaches) | Vidrio (también anti-huella)



Bianco
White
Blanc
Blanco



Argento
Silver
Argent
Plata



Grigio scuro
Dark grey
Gris foncé
Gris oscuro



Noisette
Noisette
Noisette
Noisette



Ardesia
Ardesia
Ardesia
Pizarra



Moka
Mocha
Moka
Cafe



Nero
Black
Noir
Negro



Arancione
Orange
Orange
Naranja



Rosso "F"
Red "F"
Rouge "F"
Rojo "F"



Rubino
Ruby
Rubis
Rubi



Indaco
Indigo
Indigo
Azul Indigo



Azzurro
Blue
Bleu
Azul



Verde
Green
Vert
Verde



Cedro
Lime green
Vert Cédrat
Verde Cedro

GOF

Metacrilato retrolaccato

Backpainted acrylic | Méthacrylate rétro-laqué | Metacrilato retrolacado



Bianco
White
Blanc
Blanco



Argento
Silver
Argent
Plata



Grigio scuro
Dark grey
Gris foncé
Gris oscuro



Noisette
Noisette
Noisette
Noisette

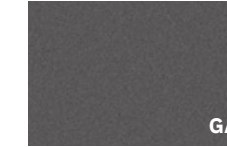

Ardesia
Ardesia
Ardesia
Pizarra

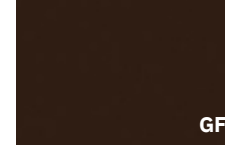

Moka
Mocha
Moka
Cafe



Nero
Black
Noir
Negro



Arancione
Orange
Orange
Naranja



Rosso "F"
Red "F"
Rouge "F"
Rojo "F"



Rubino
Ruby
Rubis
Rubi



Indaco
Indigo
Indigo
Azul Indigo



Azzurro
Blue
Bleu
Azul



Verde
Green
Vert
Verde



Cedro
Lime green
Vert Cédrat
Verde Cedro

AL

Alluminio

Aluminium | Aluminium | Aluminio



Alluminio
Aluminium
Aluminium
Aluminio

- Le finiture contenute nel presente catalogo sono puramente indicative e non sono di riferimento per le finiture del prodotto.
- Due to the printing process, finishes shown in this catalogue are for illustration only. The finish on the final item may differ slightly from the printed illustration.
- Les finitions contenues dans ce catalogue ne sont pas contractuelles - les photos ne pouvant rendre la parfaite réalité.
- Los acabados contenidos en este catálogo son puramente indicativos y no son de referencia para los suministros del producto.

Ambiente e sicurezza | Environment and safety | Environnement et sécurité | Medio ambiente y seguridad

Auraa Design utilizza per i suoi prodotti e i suoi imballi materiali facilmente separabili e riciclabili. Nella produzione dei suoi manufatti, Auraa Design si impegna ad utilizzare materiali legnosi FSC e pannelli a base di legno con certificazione CARB2. I pannelli CARB2 presentano un rilascio di formaldeide inferiore rispetto al pannello E1 comunemente utilizzato (classe E1 secondo il DM 10/10/2008).

Auraa Design uses materials that are easy to separate and recycle for its products and packaging. Auraa Design is committed to using FSC wood-based materials and CARB2-certified wood-based panels. CARB2 panels have a lower formaldehyde release than the commonly used E1 panel (class E1 according to DM 10/10/2008).

Auraa Design utilise des matériaux facilement séparables et recyclables pour ses produits et ses emballages. Dans la production de ses produits, Auraa Design s'engage à utiliser des matériaux en bois FSC et des panneaux à base de bois avec la certification CARB2. Les panneaux CARB2 dégagent moins de formaldéhyde que le panneau E1 couramment utilisé (classe E1 selon DM 10/10/2008).

Para sus productos y embalajes, Auraa Design utiliza materiales fácilmente separables y reciclables. En la fabricación de sus productos, Auraa Design se compromete a utilizar materiales de madera FSC y paneles de madera con certificación CARB2. Los paneles CARB2 tienen una menor liberación de formaldehído que el panel E1 comúnmente utilizado (clase E1 según DM 10/10/2008).

Design
Mirto Antonel

Art direction
Mirto Antonel

AD/CACD/AD

aura design



Hub Spaces, 582 Honeypot Lane, Stanmore, HA7 1JS, UK
www.auraadesign.co.uk
020 3915 8008
info@auraadesign.co.uk

