

aura
design

Priscilla



Reception counters Priscilla



Reception counters Priscilla

Priscilla reception counter is distinguished by its simple and universal form of a geometric shape. The front of the counter is appealing not only thanks to top class materials, but also LED ambient light. Priscilla reception counter is based on a metal frame with a square cross section. An add-on top is made of HPL board. Glass add-on top is available as well. Thanks to compact size, Priscilla reception counter fits perfectly into larger and smaller spaces.

WORK TOP

- Chipboard coated on both sides with melamine resin with increased durability - 1st class.
- Chipboard with reduced formaldehyde emission, E1 standard.
- 18 mm thick top finished with 2 mm thick ABS plastic edge with 3 mm radius.
- Top affixed to front at the height of 740 mm.
- Scallop cut-out as standard.
- Monitor shelf, cut-out in the work top on the right/ left side or the center and a shelf with adjustable height as an option with a surcharge. Monitor shelf excludes ergonomic outlet.



RECEPTION COUNTER FRONT

- Chipboard coated on both sides with melamine resin with increased durability - 1st class.
- Chipboard with reduced formaldehyde emission, E1 standard.
- Front and legs made of 18 mm thick board finished with 2 mm thick ABS plastic edge with 3 mm radius.
- Frame with a square cross section 20x20 mm.
- Total reception counter height - 1100 mm.



ADD-ON TOP

- Priscilla reception counter is equipped with a 12 mm thick board add-on top based on metal frame.
- 10 mm thick glass add-on top with White or Black Lacobel finish as an option with a surcharge.
- White LED ambient lightening illuminating the front on the inside as an option with a surcharge.



PLATE LEGS

- Plate legs made of a plate with a thickness 25 mm.

Priscilla

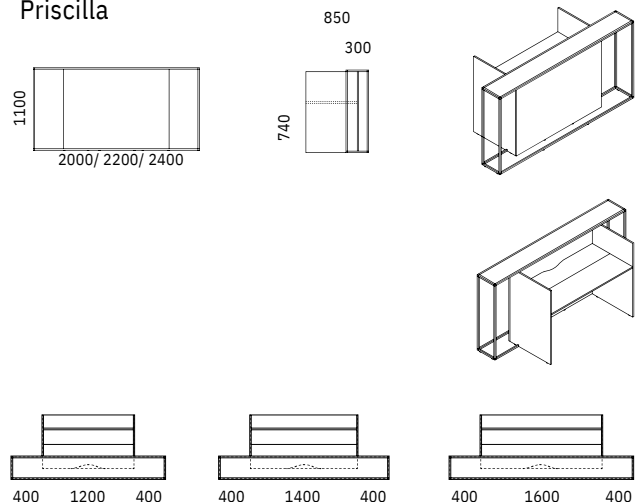

Ambient front lightening

Add-on tops of Priscilla reception counters can be equipped with white LED ambient light illuminating the front from on the inside.

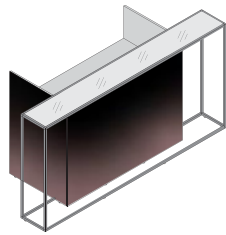

Add-on top

Priscilla reception counter is equipped with 12 mm thick board add-on top based on metal frame. 10 mm thick glass add-on top with Lacobel finish in white or black colour as an option with a surcharge.

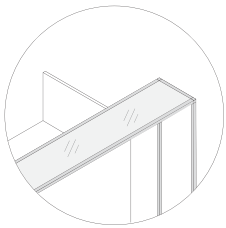

Monitor shelf

520x200 mm cut-out in the worktop located on the right or left side or in the center of the top, and a shelf with adjustable height affixed under the top as an option with a surcharge. A monitor shelf excludes an ergonomic outlet.

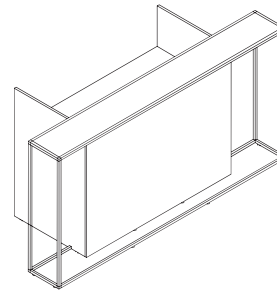
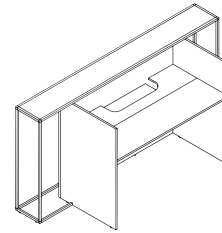

Total width:
2000/ 2200/ 2400 mm

Depth:
850 mm

Height:
1100 mm

Priscilla / Accessories

Vertical cable management

Netboxes

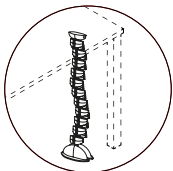

FLEXIBLE CABLE CHANNEL

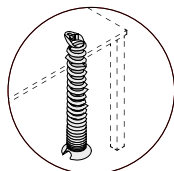

SPRING CABLE CHANNEL

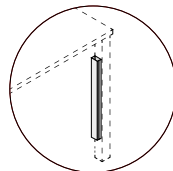

ADD-ON CABLE CHANNEL

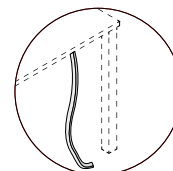

BRAIDED SLEEVE FOR CABLES

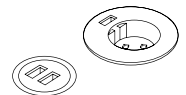

POWER CIRCLE S/M/L

Horizontal cable management

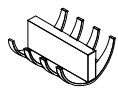

COMB CABLE CLASP

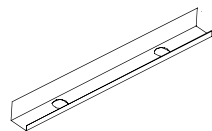

FIXED CABLE CHANNEL FOR STRAIGHT RECEPTION COUNTER

Complementary accessories

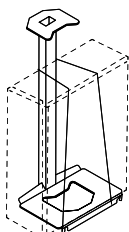

PC HOLDER

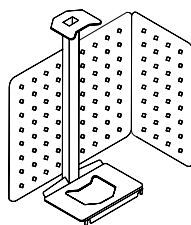

PC HOLDER WITH PERFORATED PANEL

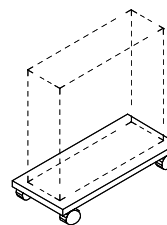

PC TROLLEY WITH CASTORS

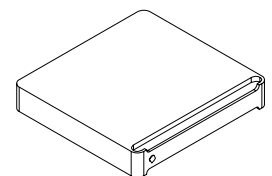

UNDERDESK DRAWER

Priscilla / Colours

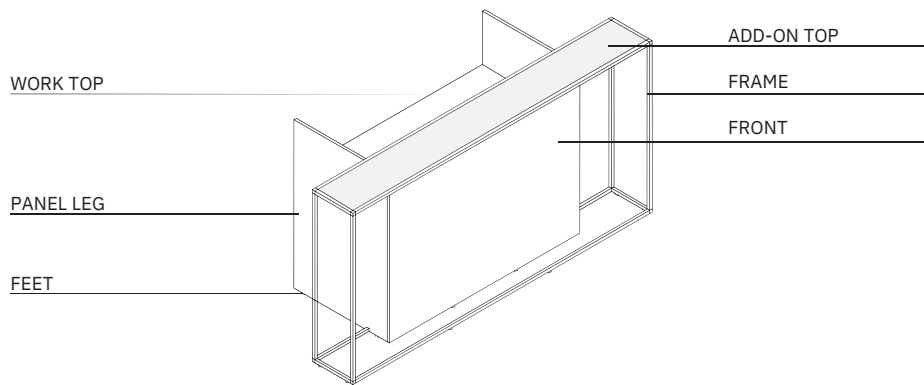

		Work top	Frame	Add-on top HPL	Front	Panel leg	Feet	
STANDARD	Melamine UNI	STD 1 White	•	•	•	•		
		STD 2 High Gloss White	•					
		STD 3 Gray	•					
		STD 4 Beige	•					
		STD 5 Norwegian Green	•					
		STD 6 Navy Blue	•					
		STD 7 Graphite	•					
		STD 8 Black	•					
	Melamine	STD 10 Acacia	•		•	•	•	
		STD 11 European Maple	•		•	•	•	
		STD 12 Napolitano Oak	•		•	•	•	
		STD 13 Gray Spruce	•		•	•	•	
		STD 14 American Oak	•		•	•	•	
		STD 15 Natural Oaky	•		•	•	•	
		STD 16 Cherry Havana	•		•	•	•	
		STD 17 Walnut Brown	•		•	•	•	
		TREND*	Melamine	TRD 1 Blush	•		•	•
TRD 2 Claret	•				•	•		
TRD 3 Dark Turquoise	•				•	•		
TRD 11 Stark Oak	•				•	•		
TRD 12 Flamed Oak	•				•	•		
STANDARD	Metal	M 02 White		•				
		M 01 Aluminium		•				
		M 03 Beige		•				
		M 05 Graphite		•				
		M 04 Black		•				
TREND*	Metal	M 06 Sunny Beige		•				
		M 09 Dirty Pink		•				
		M 08 Ginger		•				
		M 07 Faded Turquoise		•				
STANDARD	ABS	Black					•	
	Glass	GL 01 Opti White						
		GL 02 Satinato						
		GL 03 Opti Black						
		GL 04 White Lacobel			•			
		GL 05 Black Lacobel			•			

Melamine

① STANDARD



② TREND

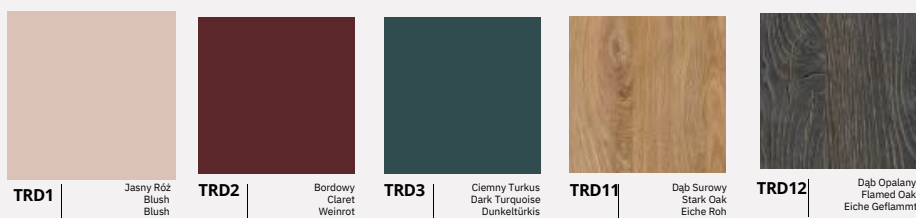

Metal

① STANDARD

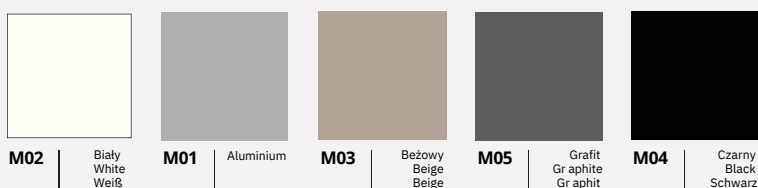

② TREND

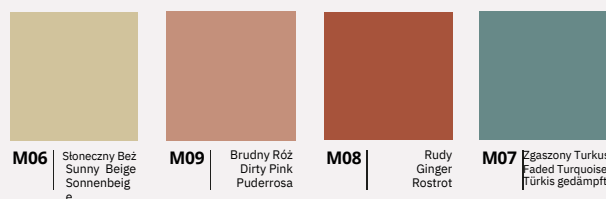

Fabrics

100% Polyester
100.000 Martindale cycles

① CALDO
Select by Lech

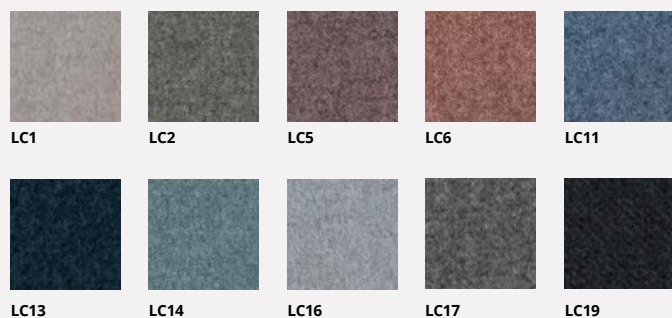

95% Virgin Wool, 5% Poliamid
100.000 Martindale cycles

② SYNERGY
Camira



100% Recycled Polyester
67.000 Martindale cycles

① TERRA
Select by Lech



aura design



Hub Spaces, 582 Honeypot Lane, Stanmore, HA7 1JS, UK
www.auraadesign.co.uk
020 3915 8008
info@auraadesign.co.uk