

aura  
design

[www.auraadesign.co.uk](http://www.auraadesign.co.uk)

PADAK



## Padak desk worktops

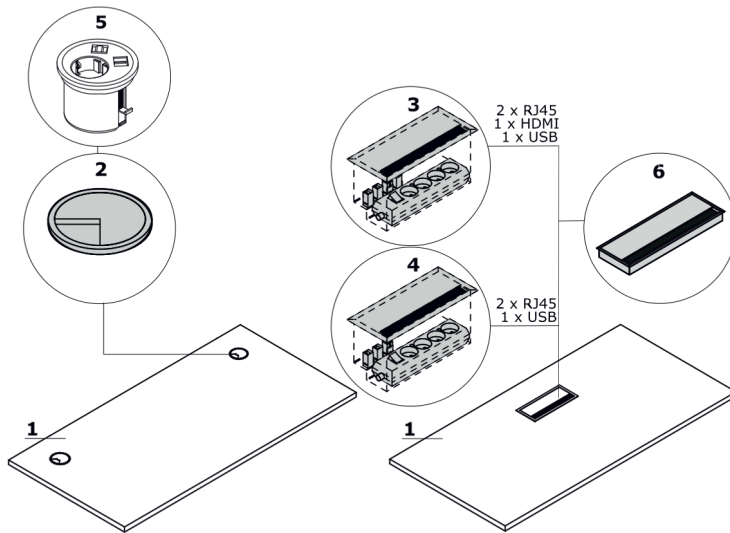

**1. Worktop** - MFC 28 mm, ABS edge

**OPTIONS WITH EXTRA CHARGE:**

**2. Grommet** - 2 pcs, Ø 80 mm

**3. Mediabox** - 2 x RJ45 (class E, cat. 6); + 1 x USB + 1 x HDMI+4 x 230V

**4. Mediabox** - 2 x RJ45 (class E, cat. 6); + 1 x USB + 4 x 230V

**5. Mediabox** - 1 x 230V + 1 x USB charger + 1 x RJ45, colour: black, white, mounted instead of the existing grommet Ø80 mm

**6. Top access**

**7. Cable way** - the width of the opening is proportional to the width of the worktop

**8. Mediabox + cable grommets**

**9. Cable way + cable grommets** - desks, bench desks

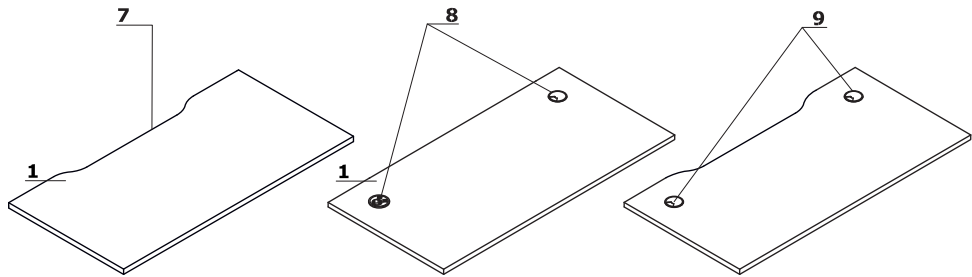

## Frame

**Padak:** metal, powder coated, profile 40 × 40 mm, spacer 10 mm between top and frame

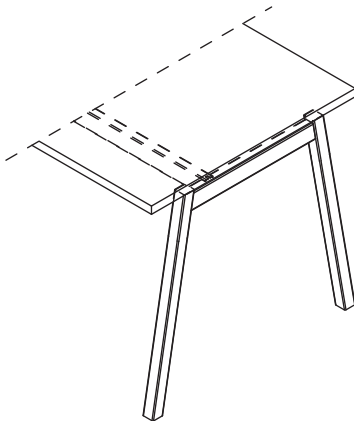

Attention - cable tray under the worktop is always – aluminium semi-matt colour.  
Attention - leveling - 10 mm range.

## Configuration examples

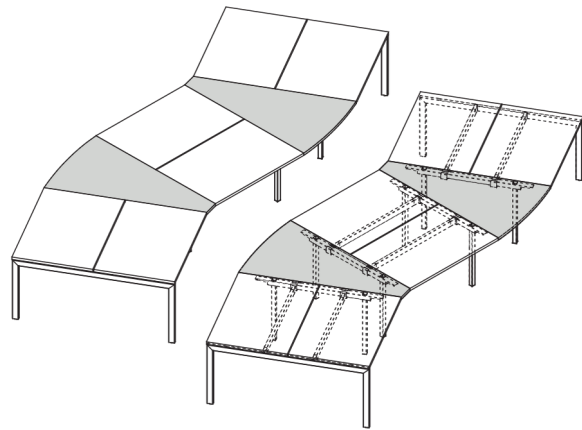
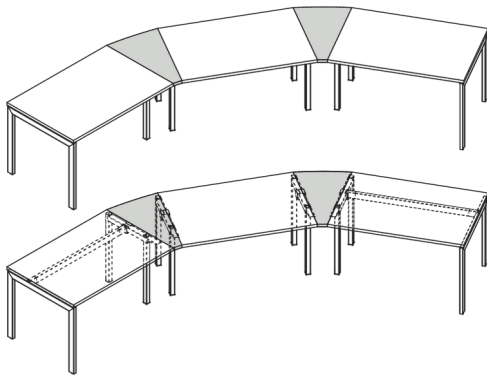

## Accessories

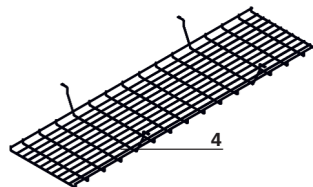
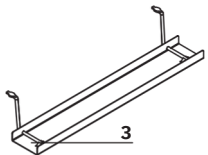
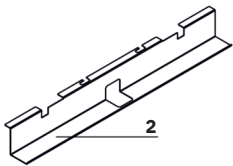
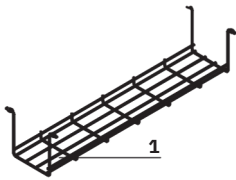

1. Horizontal cable tray - powder coated
2. Single desk horizontal cable tray - powder coated metal
3. Horizontal cable tray - powder coated
4. Cable tray for bench desks - steel wire Ø4 mm, powder coated

www.auiraaesign.co.uk

## Sliding top

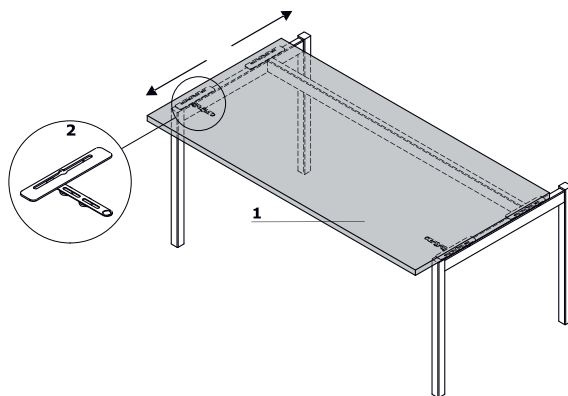

1. Sliding top - shifting range 141 mm
2. Tabletop sliding lock

## Power strip - for series connection

1. set for 1 workstation - power strip (3x SCHUCKO, 2x RJ45) x1 + power cord (universal outlet PL/FR/Schucko)
2. set for 2 workstation - power strip (3x SCHUCKO, 2x RJ45) x2 + set of power cords (universal outlet PL/FR/Schucko)
3. set for 3 workstation - power strip (3x SCHUCKO, 2x RJ45) x3 + set of power cords (universal outlet PL/FR/Schucko)

1

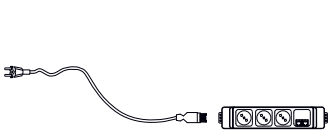

2

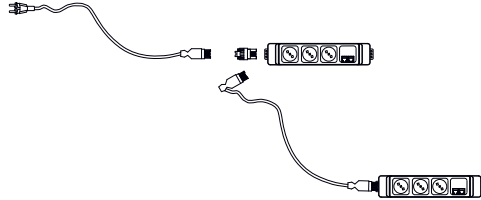

3

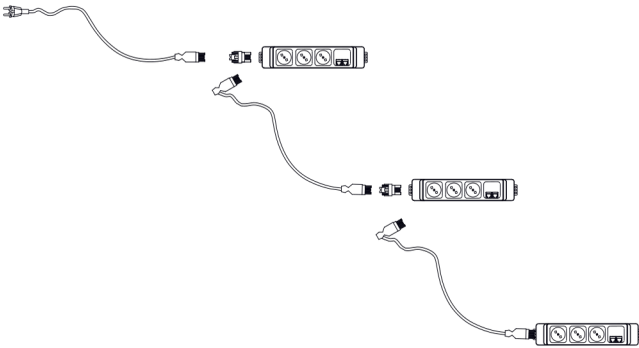

## Elements for desks pairing

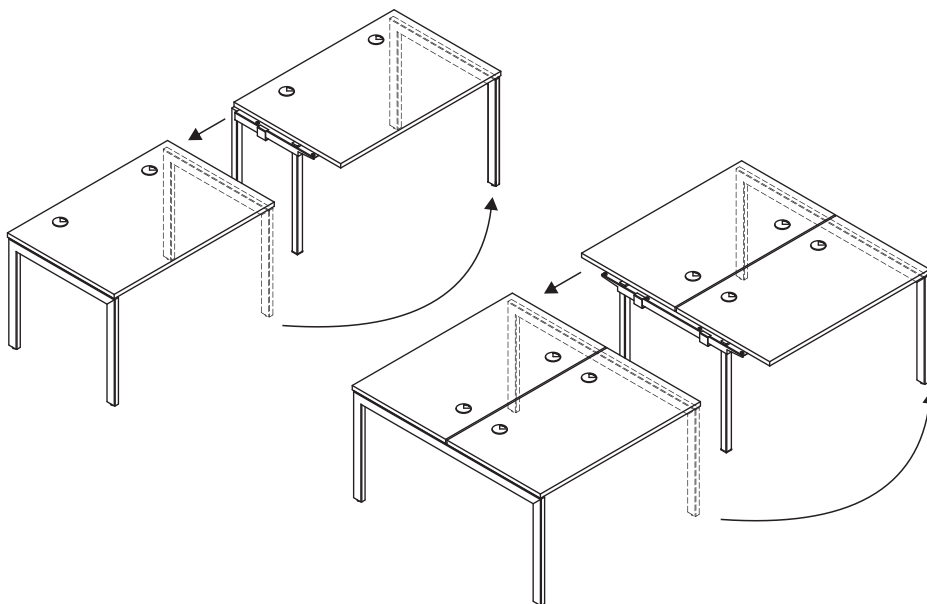

## Desks \*



1000 / 600 / 740  
24.4 kg



1200 / 600 / 740  
26.3 kg

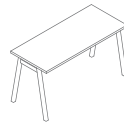

1400 / 600 / 740  
33.05 kg

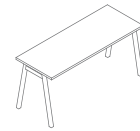

1600 / 600 / 740  
32.5 kg



1000 / 700 / 740  
27.05 kg



1200 / 700 /  
740 32.7 kg



1400 / 700 /  
740 33.8 kg



1600 / 700 / 740  
40.5 kg



1200 / 800 / 740  
35 kg



1400 / 800 / 740  
37.75 kg



1600 / 800 / 740  
42.05 kg



1800 / 800 / 740  
46.55 kg



2000 / 800 / 740  
49.6 kg

## Elements for arrangement building - straight desk \*



1000 / 600 / 740  
20.87 kg

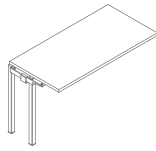

1200 / 600 / 740  
22.7 kg

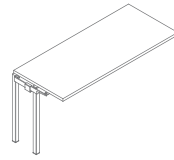

1400 / 600 / 740  
29.45 kg

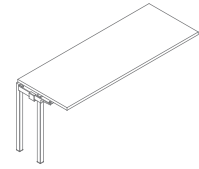

1600 / 600 / 740  
28.9 kg

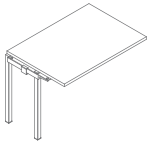

1000 / 700 / 740  
23.45 kg

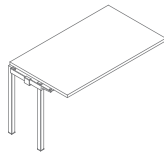

1200 / 700 /  
740 29.1 kg

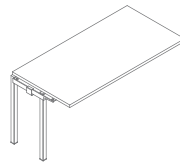

1400 / 700 /  
740 30.2 kg

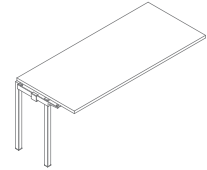

1600 / 700 / 740  
36.9 kg



500 / 800 / 740  
11 kg

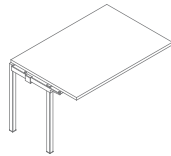

1200 / 800 / 740  
30.8 kg

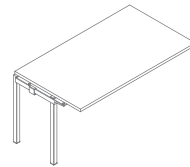

1400 / 800 / 740  
33.55 kg

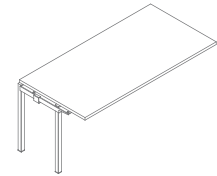

1600 / 800 / 740  
37.85 kg

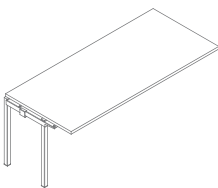

1800 / 800 / 740  
42.35 kg

\* dimensions expressed in millimetres: width x depth x height

## Desk extensions \*



600 / 800 / 740  
15.65 kg



600 / 1000 / 740  
19.4 kg



600 / 1200 / 740  
20 kg

## Power strip



500 / 430 / 569  
1.1 kg



500 / 430 / 569  
1.6 kg

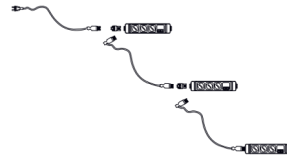

500 / 430 / 569  
2.1 kg



## Worktop, top, base, body, front



Aluminum satinato



Canadian oak



Polar birch



Cocoa



Natural oak



Honey oak



Acacia



White pastel



Dark walnut



Lowland walnut



Anthracite



Black



Grey oak

www.auraaadesign.co.uk

## Frame - metal



Aluminum semi-matt



White semi-matt



Antracite semi-matt



Black semi-matt



Olive semi-matt



Blue semi-matt



Brick red semi-matt



Yellow semi-matt



Beige semi-matt

## Mediabox - metal



Aluminum semi-matt



White semi-matt



Antracite semi-matt



Black semi-matt

## Grommets



Grey



Black



Beige

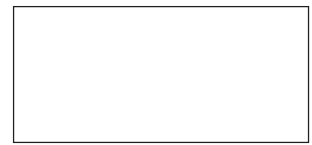

White pastel

## Accessories



Aluminum semi-matt



White semi-matt



Black semi-matt

# aura design



Hub Spaces, 582 Honeypot Lane, Stanmore, HA7 1JS, UK  
[www.auradesign.co.uk](http://www.auradesign.co.uk)  
020 3915 8008  
[info@auradesign.co.uk](mailto:info@auradesign.co.uk)