

aura
design

Oakley

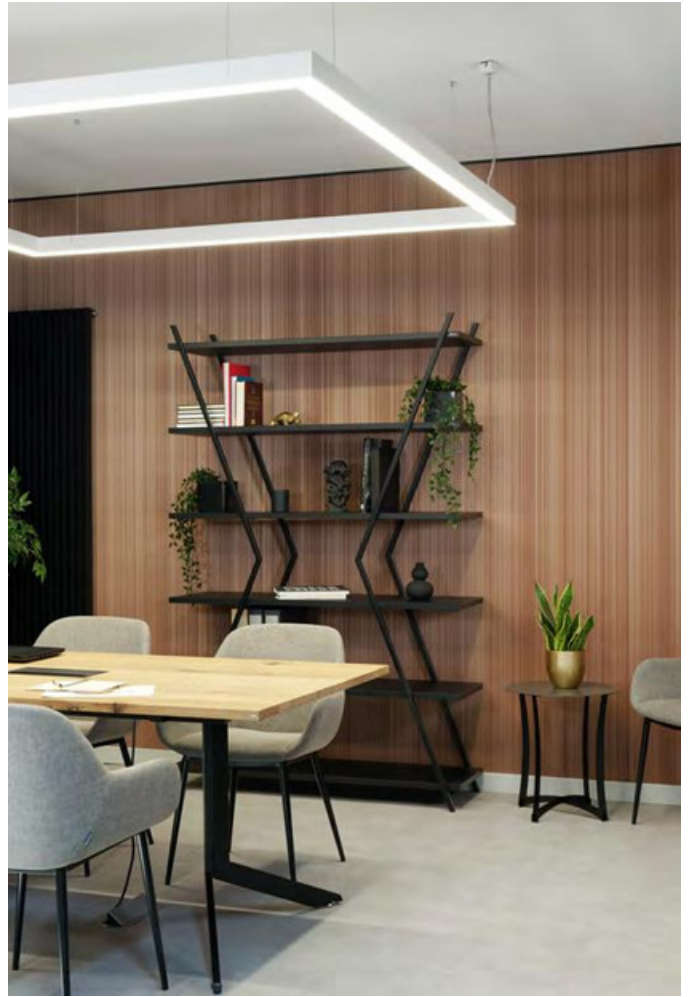

Oakley Tables





Oakley is a collection of conference and executive furniture. It features both large and smaller conference tables. The tables can be based on different types of legs A-, X - and Y-shaped.

A wide range of tops and dimensions makes this collection a perfect solution for any office. Cabinets and showcases complete the collection.

STRUCTURE

- Chipboard coated on both sides with melamine resin with increased durability - 1st class.
- Chipboard with reduced formaldehyde emission, E1 standard.
- Top finished with 2 mm thick ABS plastic edge with 3 mm radius.
- Top made of 25 mm thick board.



Oakley A



– A-shaped system leg made of rectangular profile 60x20 mm.

Oakley X



– X-shaped system leg made of rectangular profile 60x20 mm.

Oakley Y



– Y-shaped system leg made of rectangular profile 60x20 mm.



FRAME

- 3 base types: A-shaped leg, X-shaped leg, Y-shaped leg.
- System leg welded on the inside.
- Metal, undertop beams made of 45x45 mm profiles.
- Powder-coated frame.



HEIGHT

- Fixed height 740 mm, leveling feet +10 mm.

Oakley / Features

Frame

Oakley A

1. System leg A welded on the inside, made of rectangular profile 20x60 mm.
2. Powder-coated, metal undertop beams made of 45x45 mm profiles.

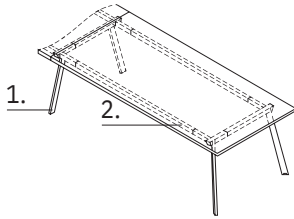

Outer leg A

Inner leg A

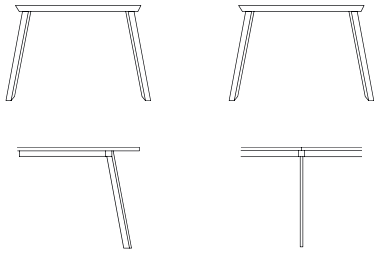

Oakley X

1. System leg X welded on the inside, made of rectangular profile 20x60 mm.
2. Powder-coated, metal undertop beams made of 45x45 mm profiles.

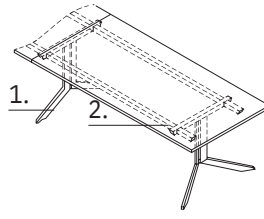

Outer leg X

Inner leg X

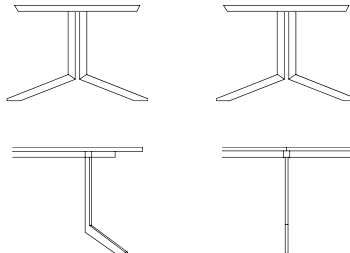

Oakley Y

1. System leg X welded on the inside, made of rectangular profile 20x60 mm.
2. Powder-coated, metal undertop beams made of 45x45 mm profiles.

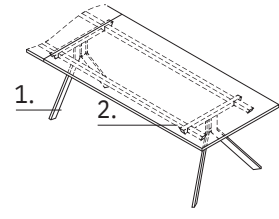

Outer leg Y

Inner leg Y

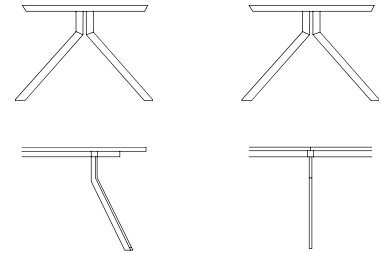

Oakley / Equipment

Cable channel

Oakley tables can be equipped with vertical and horizontal cable channels adjusted to every table type.

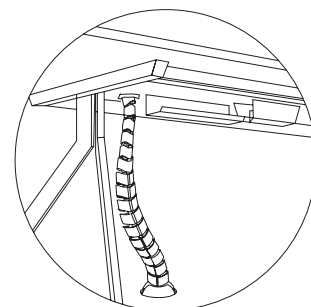
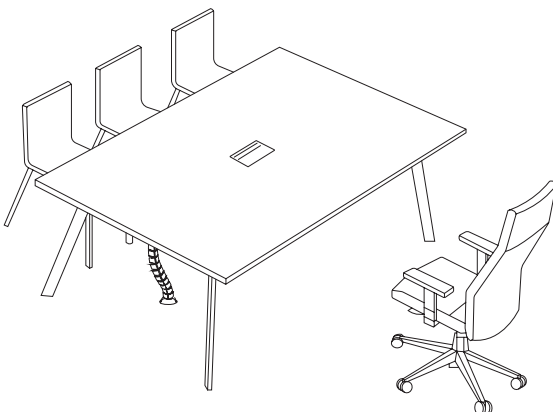

Netbox

Possibility to select and mount a netbox to every Oakley table.

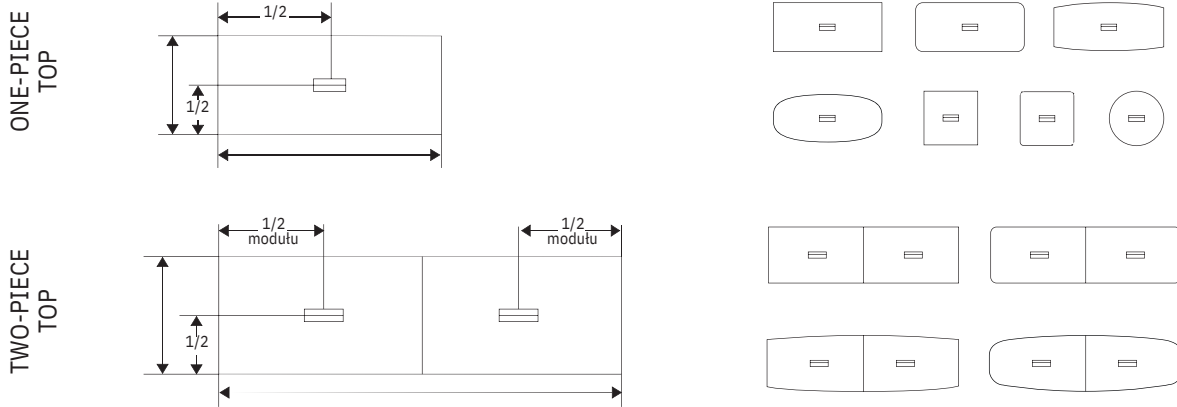

Graining

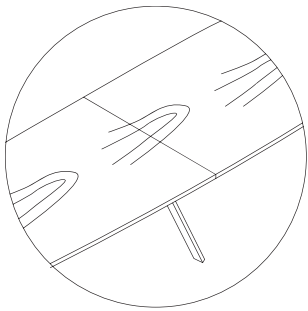

In two-piece tops continuous graining as standard. Minor displacement possible.

Chromium plated feet

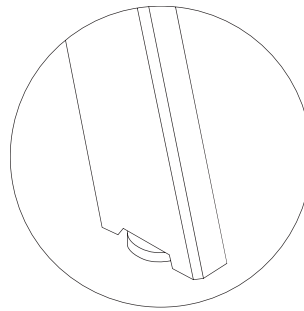

All Oakley tables are equipped with chromium plated feet with leveling function + 10 mm.

Oakley / Accessories

Horizontal cable management

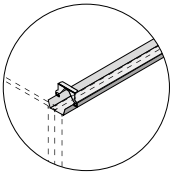

FIXED CABLE CHANNEL

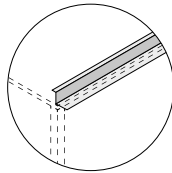

FOLD-DOWN CABLE CHANNEL

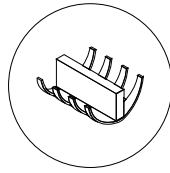

COMB CABLE CLASP

Vertical cable management

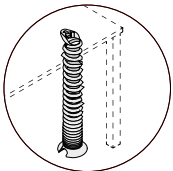

SPRING CABLE CHANNEL

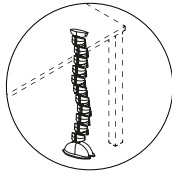

FLEXIBLE CABLE CHANNEL

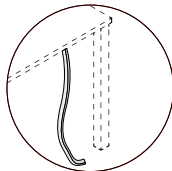

BRAIDED SLEEVE FOR CABLES

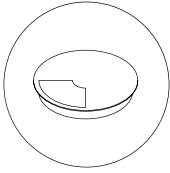

ROUND CABLE
OUTLET

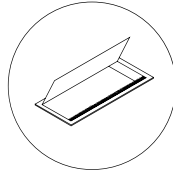

ALUMINUM CABLE
OUTLET

Netboxes

Cable outlets

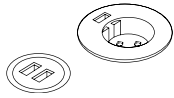

POWER CIRCLE S/M

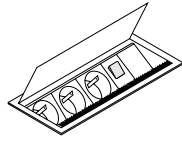

NETBOX

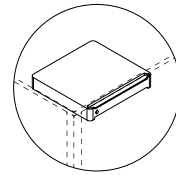

UNDERDESK DRAWER

Conference tables with rectangular tops

Conference tables with rectangular tops and rounded corners

Oakley A

Oakley X

Oakley Y

Oakley A

Oakley X

Oakley Y

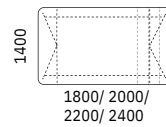
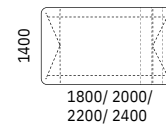
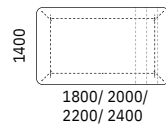
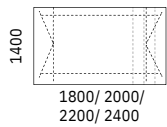
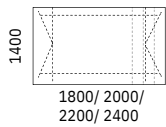
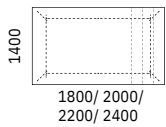
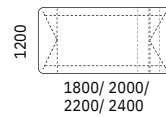
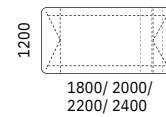
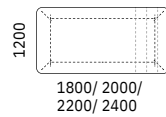
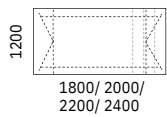
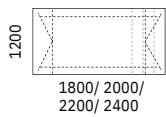
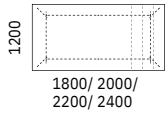
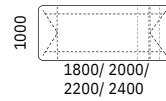
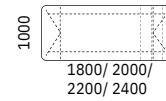
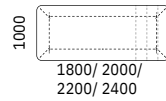
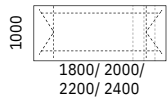
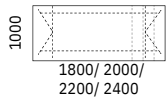
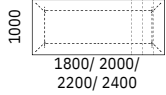
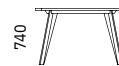
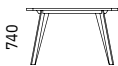
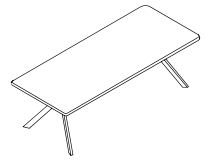
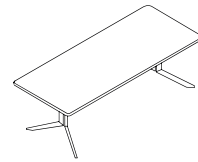
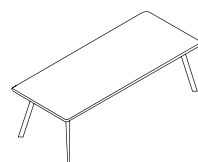
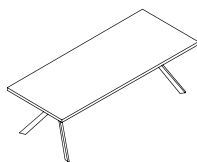
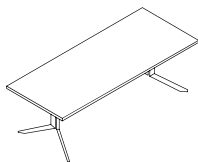
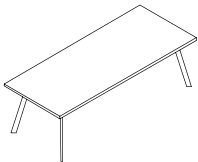

Tables with barrel-shaped tops

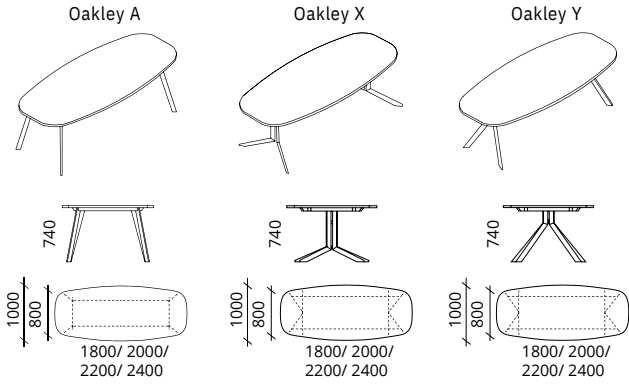

Conference tables with rectangular tops

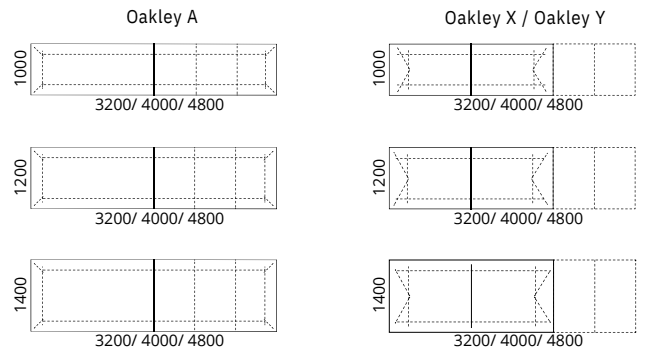
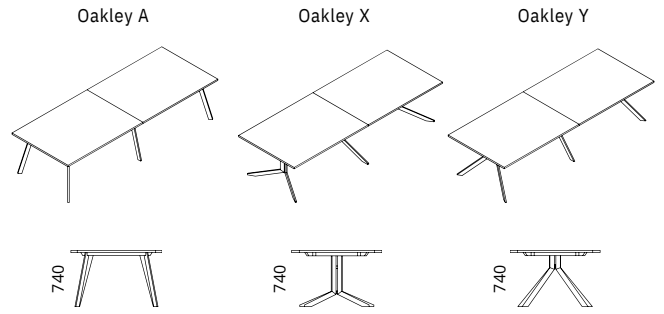

Conference tables with rectangular tops and rounded corners

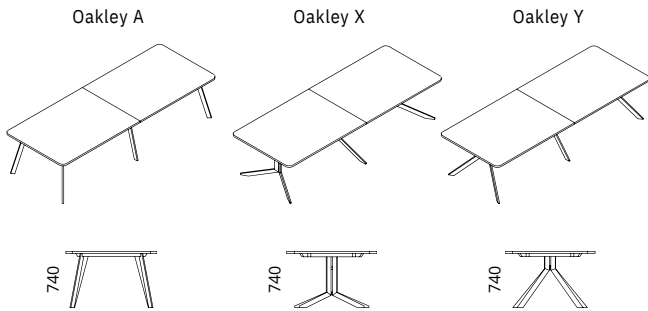

Conference tables with barrel-shaped tops

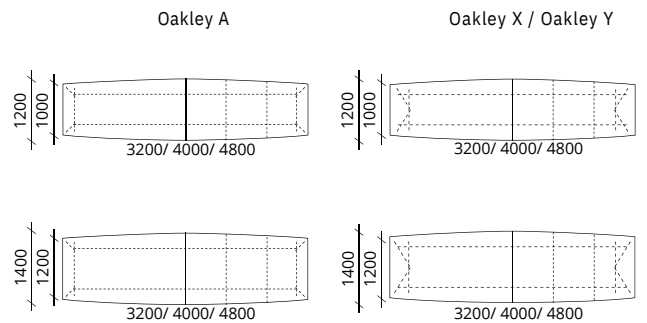
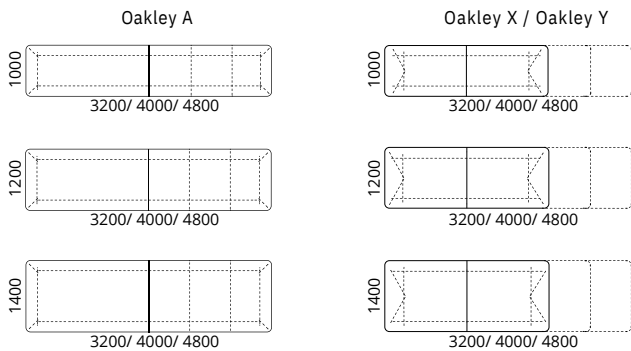
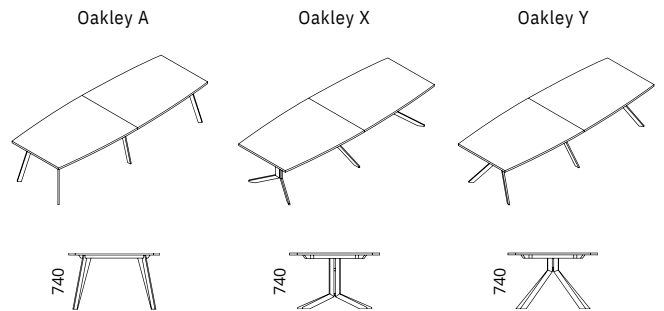

Conference tables with oval tops

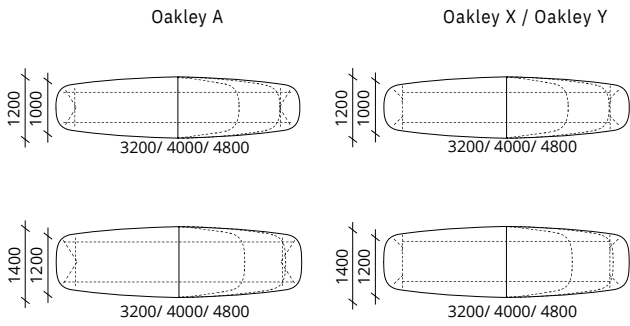
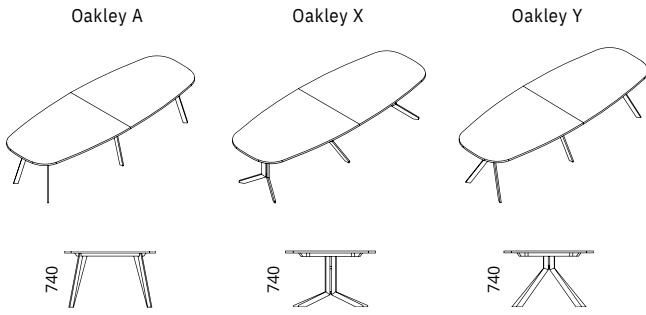

Extension modules for Oakley A* conference tables

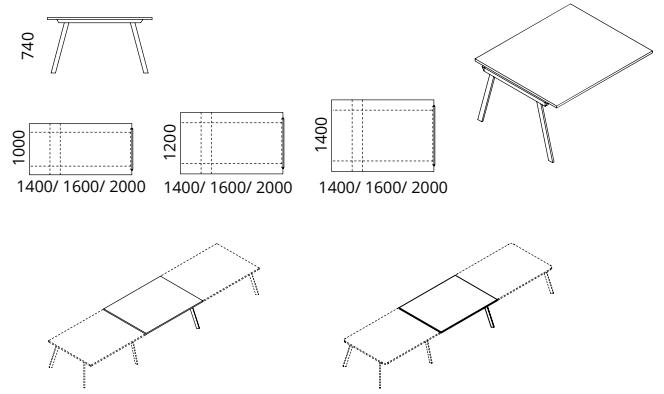

Extension modules for Oakley X* conference tables

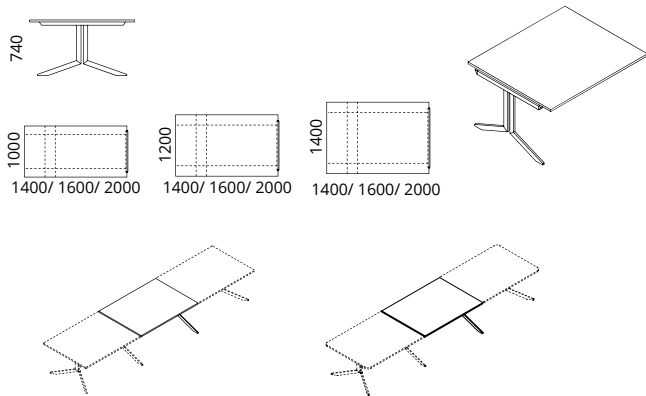

Extension modules for Oakley Y* conference tables

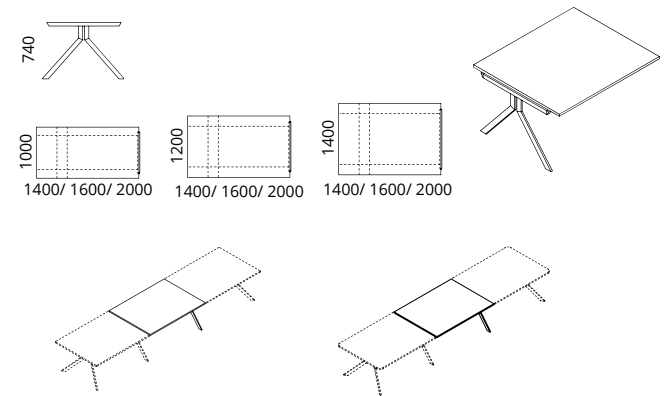

Oakley / Colours

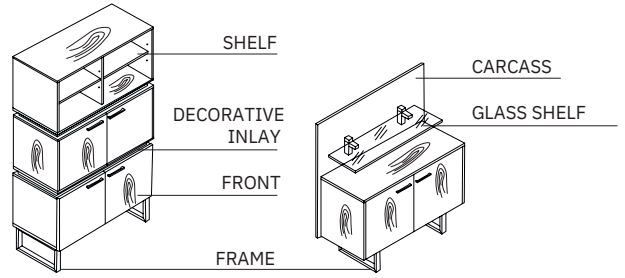
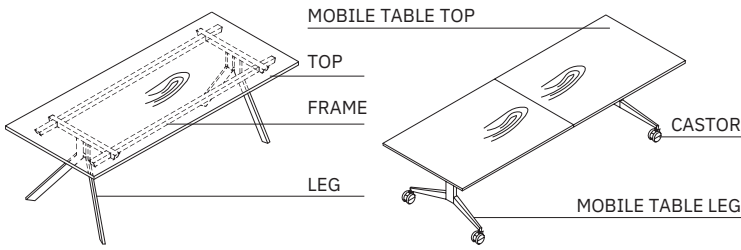

			Top	Mobile table top	Front	Decorative inlay	Carcass	Shelf	Glass shelf
STANDARD	Melamine UNI	STD 1 White	•	•	•	•	•	•	
		STD 2 High Gloss			•				
		STD 3 White Gray	•	•					
		STD 4 Beige	•	•	•				
		STD 5 Norwegian	•	•	•				
		STD 6 Green Navy Blue	•	•	•				
		STD 7 Graphite	•	•	•	•			
		STD 8 Black	•	•	•				
	Melamine	STD 10 Acacia	•	•	•				
		STD 11 European Maple	•	•	•				
		STD 12 Napolitano Oak	•	•	•				
		STD 13 Gray Spruce	•	•	•				
		STD 14 American Oak	•	•	•				
		STD 15 Natural Oaky	•	•	•				
		STD 16 Cherry Havana	•	•	•				
		STD 17 Walnut Brown	•	•	•				
		TREND*	Melamine	TRD 1 Blush			•		
TRD 2 Claret					•			•	
TRD 3 Dark Turquoise					•			•	
TRD 11 Stark Oak					•			•	
TRD 12 Flamed Oak					•			•	
PREMIUM**	HPL	FX1 Fenix Black	•						
		FX2 Fenix White	•						
	Solid wood	RW1 Lacquered	•						
		RW2 Oak Oiled Oak	•						
	Stone	ST 1 Nero Greco	•						
		ST 2 Noir Desir	•						
		ST 3 Bianco Venato	•						
Veneer	VR 4 Burundi Mahogany	•							
	VR 5 Brazilian Rosewood	•							
	VR 6 Flader Oak	•							
+	Dry-wipe board		•						
STANDARD	Glass	GL 01 Opti White						•	•
		GL 02 Satinato						•	•
		GL 03 Opti Black						•	•
		GL 04 White Lacobel							
		GL 05 Black Lacobel							

		Frame	Leg	Castor	Mobile table leg
STANDARD	Metal	M 02 White	•	•	•
		M 01 Aluminium	•	•	
		M 03 Beige	•	•	
		M 04 Black	•	•	•
		M 05 Graphite	•	•	
TREND*	ABS Metal	M 06 Sunny Beige			
		M 07 Faded Turquoise			
		M 08 Ginger			
		M 09 Dirty Pink			
ABS Metal	Black		•		

* Only 18 mm thick panel boards from trend group available.

**Products in premium colors are priced individually. Information on lead time can be obtained from a sales representative.

Melamine

① STANDARD



② TREND

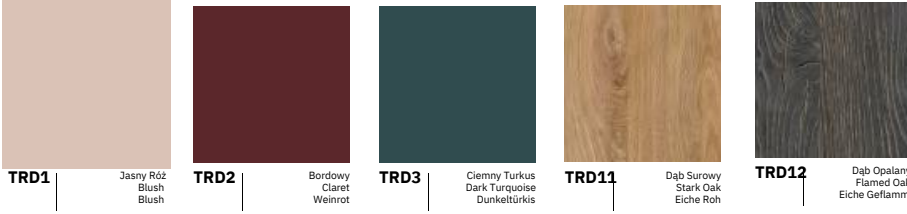

Metal

① STANDARD



② TREND

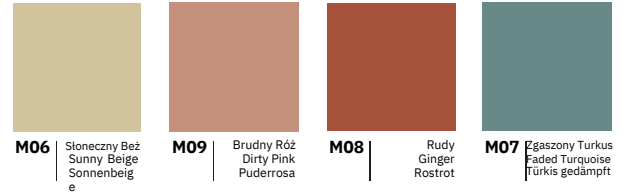

Fabrics

100% Polyester
100.000 Martindale cycles

① CALDO
Select by Lech

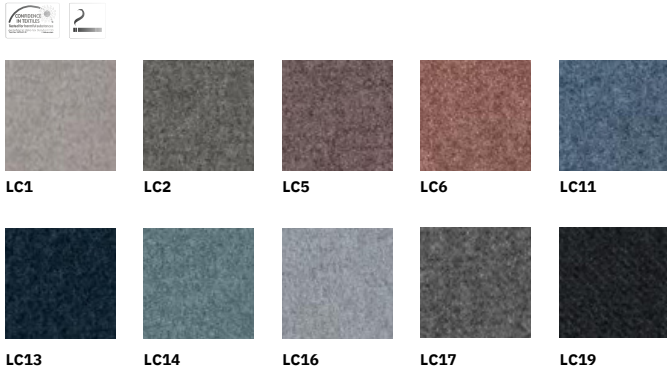

95% Virgin Wool, 5% Poliamid
100.000 Martindale cycles

② SYNERGY
Camira



100% Recycled Polyester
67.000 Martindale cycles

① TERRA
Select by Lech



aura design



Hub Spaces, 582 Honeypot Lane, Stanmore, HA7 1JS, UK
www.auraadesign.co.uk
020 3915 8008
info@auraadesign.co.uk