

aura  
design

# Marcell

---

workstations

## Solo l'essenziale

Il pratico sistema di fissaggio a molla, rende Marcell una struttura solida, affidabile e performante nel tempo.

The practical spring fastening system makes Marcell a solid, reliable and long-lasting structure.

Le système pratique de fixation par ressort fait d'Marcell une structure solide, fiable et durable.

El práctico sistema de fijación por muelle hace de Marcell una estructura sólida, fiable y duradera.

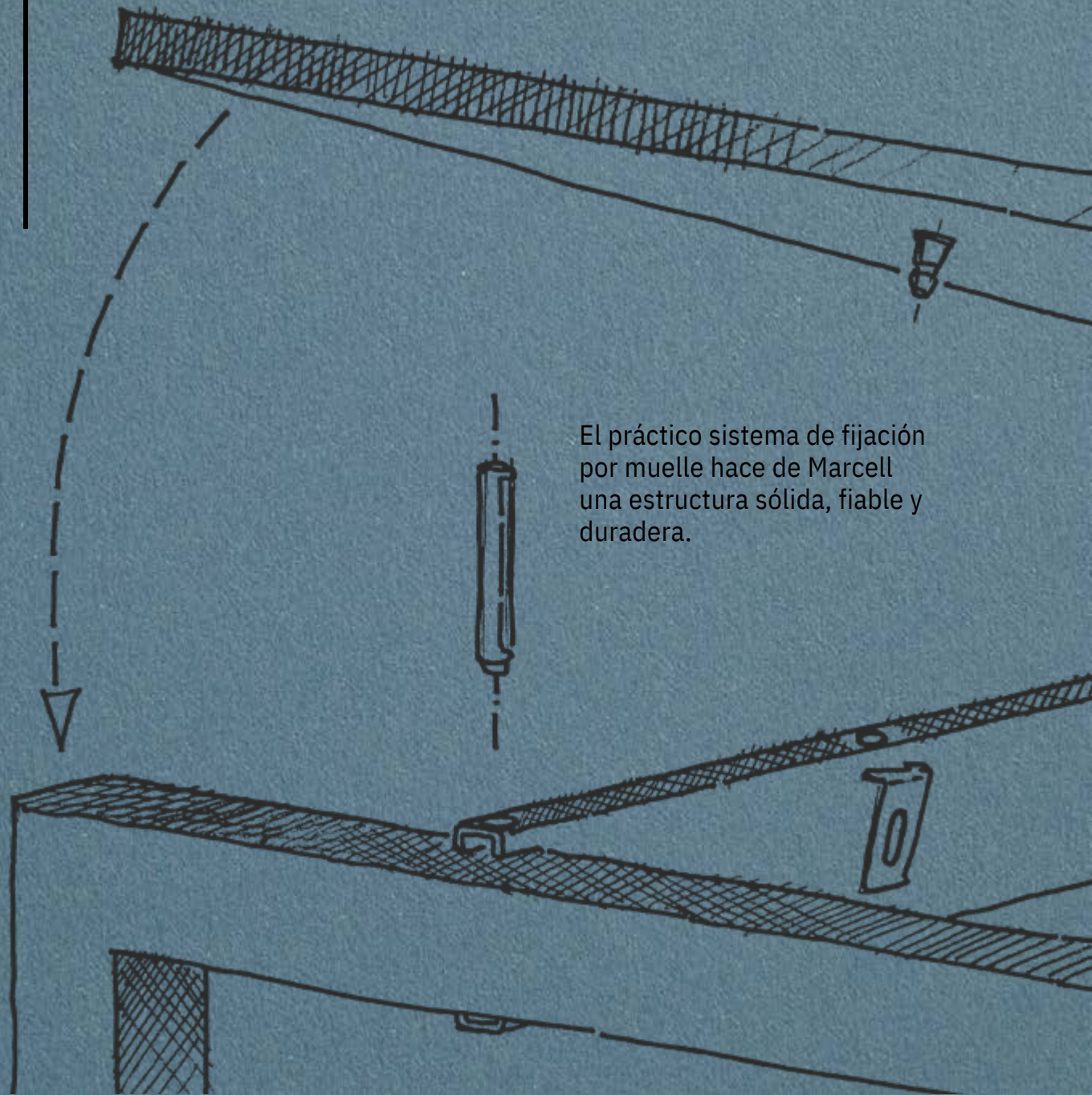

# Marcell

## Sistema intelligente

Marcell è un sistema dalle sorprendenti prerogative tecniche ma dai costi contenuti. Si compone di una struttura metallica trave/cavallo di supporto ai piani di spessore 18 mm.

**Smart system** Marcell system combines great technical features with cost efficient components. A metal structure with horizontal beams and straight legs, supports tops 18 mm (11/16") thick.

**Système intelligent** Marcell est un système aux surprenantes caractéristiques techniques mais au prix contenu. Le système se compose d'une structure métallique poutre/pied arche à support de plateaux de 18 mm d'épaisseur.

**Sistema inteligente** Marcell es un sistema de sorprendentes características técnicas a un precio razonable. El sistema consta de una estructura metálica de patas/vigas que soporta superficies de 18 mm de espesor.



# Marcell



# Marcell

## Fissaggio

Il fissaggio dei piani alla struttura avviene grazie a perni conici che si inseriscono su molle metalliche applicate alle travi. Il piano si installa solo a pressione, senza l'utilizzo di viti. Le travi orizzontali forniscono anche il supporto agli accessori.



**Fixation** la fixation des plateaux sur la structure se fait grâce à des goujons coniques qui sont insérés dans des ressorts métalliques intégrés aux poutres. Le plan de travail est installé simplement par pression, aucune vis. Les poutres horizontales servent également de support aux accessoires.

**Fijación** los sobres de mesa, se conectan a la base por medio de pernos que se introducen en resortes metálicos aplicados en las vigas. La sola presión del peso es suficiente para instalar el top, sin necesidad de tornillos. Las vigas horizontales también sirven para colocar los accesorios.

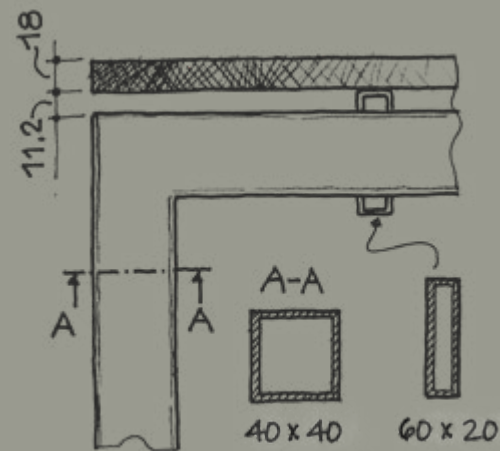

## Marcell

**Fixing** the worksurface is secured to the structure through conical pins which are inserted onto metal springs applied to the beams. The table top is installed only by pressure, without the use of screws. The horizontal beams also provide support to several accessories.





Marcell 2

**Options** Marcell tops can be in melamine, with a solid colour or wood-effect finish, or in back-lacquered glass, also in the anti-fingerprint version.

**Options** Les plateaux Marcell peuvent être en mélamine, avec finition unie ou effet bois, ou en verre laqué, également dans la version antitaches.

**Opciones** Los sobres Marcell pueden ser de melamina, con un acabado de color sólido o de efecto madera, o de cristal retro-lacado, también en la versión anti-huella.



## Marcell 2

### Opzioni

I piani Marcell possono essere in melaminico, con finitura in tinta unita o effetto legno, oppure in vetro retrolaccato anche nella versione antimpronta.





Marcell 2

# Marcell 1



# Marcell 1





# Marcell 1

**Accesorios** La superficie de trabajo puede llevar una ranura pasacables o un cepillo suave para permitir la salida de los cables en la encimera. El bench Marcell puede ser equipado con contenedores aéreos, abiertos, compartidos y pantallas enganchadas en tejido pinchable.



## Accessori

Il piano può essere dotato di asola passacavi o di spazzola morbida per consentire l'uscita dei cavi sul piano lavoro. Il bench Marcell può essere attrezzato con corpetti contenitori, a giorno, condivisi e screen agganciati in tessuto tackable.

**Accessories** The top can be provided with grommets or soft brush flip top that allow cables to reach easily the top of the worksurface. Screens may be tackable and cubbies can be added and shared in a bench configuration.

**Accessoires** Le plateau peut être équipé avec une brosse douce qui permet la sortie des câbles sur le plan de travail. Le poste double Marcell peut recevoir soit des petits rangements ouverts partagés soit des écrans de séparation "tackable" en tissu.



# Marcell 2

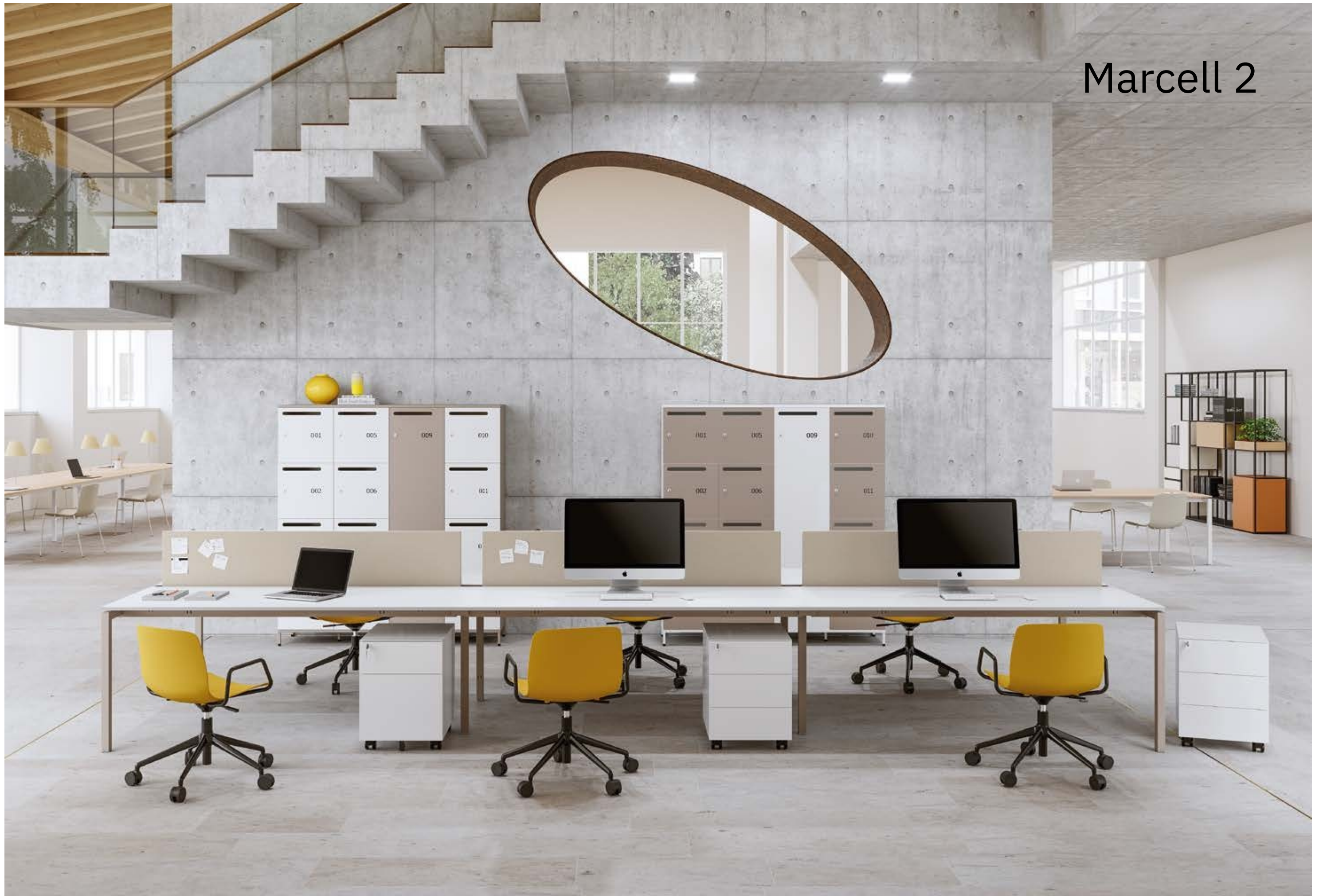

# Marcell 1

## Cablaggio

Il sistema di traslazione dei piani lavoro nelle postazioni contrapposte consente un facile accesso al vano centrale dove vengono raccolti i cavi. Questo spazio condiviso può essere attrezzato con una vasca in metallo o una rete metallica effetto cromato.

**Wiring** In the face to face stations, Marcell sliding system allows easy access to the center through where the cables run. The channel can be in metal or in a grid chrome version.

**Câblage** L'option des plateaux à coulisse permet, en hâlant la surface de travail, de libérer l'accès à l'aire de connexion où se trouve le câblage. Celui-ci est véhiculé par des canaux réalisés soit en maillage d'acier chromé soit en tôle peinte pliée en U.

**Cableado** Las superficies con sistema deslizable en los escritorios compartidos permite un acceso fácil al canal central que distribuye los cables y conexiones. Este canal compartido puede ser una canasta en rejilla de metal cromado o una bandeja metálica en U.



Marcell 3



Marcell 3





## Marcell 3

### Riunioni

Marcell consente, grazie alla propria struttura, di realizzare tavoli riunione con campata sino a 300 cm senza l'ausilio di supporti intermedi. Ai tavoli si possono abbinare eleganti librerie modulari in varie finiture oppure mobili contenitori.

**Meetings** Marcell beam system allows the building of conference tables 300 cm (10 feet) long without an intermediate support. These tables can be paired with modular bookcases and elegant cabinets.



**Réunions Marcell** grâce à son concept structurel permet de concevoir des tables de réunion jusqu'à 300 cm sans support intermédiaire. Ces tables proposent en complément d'élegants bibliothèques à jour (déclinées dans toutes les finitions Auraa Design) ou alors des armoires.

**Reuniones** Gracias al soporte fuerte de las estructuras, Marcell permite confeccionar mesas de hasta 300 cm sin soportes intermedios. Las mesas se pueden complementar con elegantes libreros modulares en varios acabados o con archivos.



①

1. Tavoli lunghezza extra, 300 mm | 2. Accessori agganciati alla struttura (screen, modesty panel, porta CPU) | 3. Rapido fissaggio del top | 4. Componenti della struttura | 5. Gamba regolabile in altezza | 6. Piano traslabile | 7. Design lineare



②

1. Extra long tables, 300 mm (10 feet) | 2. Accessories hanged to the structure (screen, modesty panel, CPU holder) | 3. Quick top linking | 4. Structure components | 5. Height adjustable leg | 6. Sliding desk top | 7. Clean design

③



1. Tables extra-longues, 300 mm | 2. Accessoires fixés à la structure (ecran, voile de fond, Support U.C.) | 3. Fixation rapide du top | 4. Composants de la structure | 5. Pied réglable en hauteur | 6. Plateau coulissant | 7. Design linéaire



④

⑤



⑥



⑦

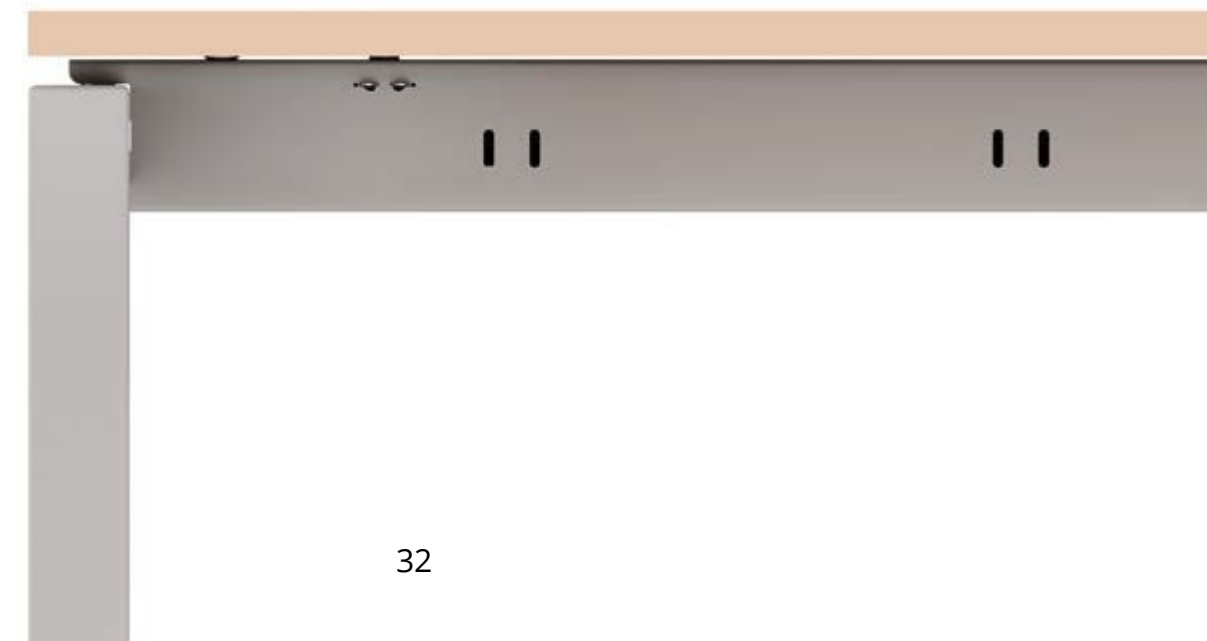

8

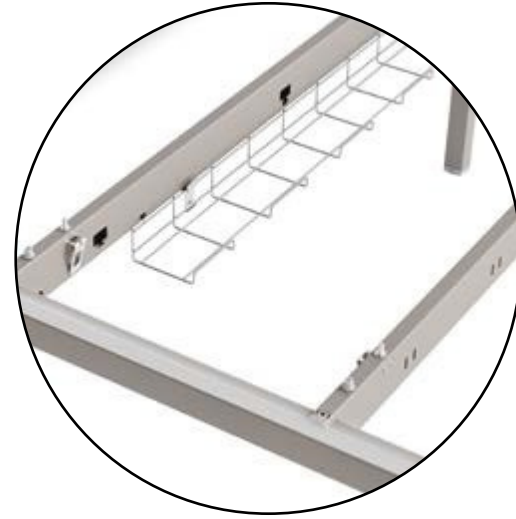

8. Cestello portacavi in filo d'acciaio | 9. Canala portacavi in metallo | 10. Gestione dei cavi nella soluzione bench | 11. Canale metalliche magnetiche per il transito verticale dei cavi | 12. Coppia di carter per la salita cavi

8. Basket for cable management | 9. Metal tray for cable management | 10. Cable management for bench solutions | 11. Magnetic vertical cable duct | 12. Double vertical cable duct

9



8. Panier passecables en fil d'acier | 9. Goulotte passecables en tôle d'acier | 10. Gestion des câbles dans la solution bench | 11. Goulottes verticales magnétiques pour passage câbles | 12. Goulotte double verticale passecables

8. Viga portacables en rejilla de acero | 9. Viga portacables | 10. Gestión de cables en la solución bench | 11. Canalización magnética para salida cables | 12. Canalización central para salida cables

10



11

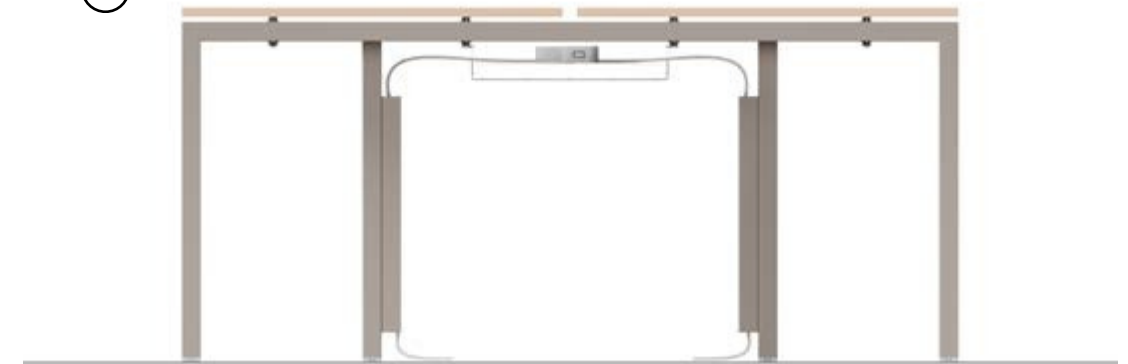

12



Piani | Desk tops | Plateaux | Sobres

**Melaminico/vetro**  
Melamine/glass  
Mélaminé/verre  
Melaminico/vidrio



**Piani fissi o traslabili A. semplici, B. con spazzolino, C. con scanso passacavi**  
Fixed or sliding desk tops A. simple, B. with brush, C. with frontal shaping for cable transit  
Plateaux fixes ou coulissants A. simples, B. avec brosse passe-cables, C. avec façonnage frontal pour le passage des câbles  
Sobres fijas o deslizantes A. simples, B. con escobillas, C. con pasacables frontal

Gambe | Legs | Pieds | Patas

**Metallo verniciato epossidico**  
Metal epoxy painted  
Métal peint époxy  
Metal pintado epoxi

Gli screen sono disponibili nelle finiture: melaminico, goffrato, metacrilato, tessuto  
Screens are available in the following finishes: melamine, embossed, acrylic, fabric.  
Les écrans sont disponibles dans les finitions: mélaminé, gaufré, méthacrylate, tissu  
Los paneles están disponibles en los siguientes acabados: melaminico, lacado, metacrilato, tejido

Scrivanie | desks | bureaux | mesas



L 100/120/140/160/180/200 - P 80/90 cm  
W 39 3/8"-47 1/4"-55 1/8"-63"-70 7/8"-78 3/4" - D 31 1/2"-35 3/8"

Dattilo | returns | retours | alas

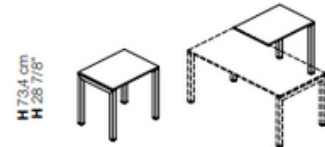

L 80/100/120 - P 60 cm  
W 31 1/2"-39 3/8"-47 1/4" - D 23 5/8"

Tavoli riunione | meeting tables | tables de réunion | mesas de juntas



L 120/160 - P 123/163 cm  
W 47 1/4"-63" - D 48 3/8"-64 1/8"



L 210/240/300 - P 123 cm  
W 82 5/8"-94 1/2"-118 1/8" - D 48 3/8"

Esempi composizioni | composition exemple | exemples de compositions | ejemplos de composiciones

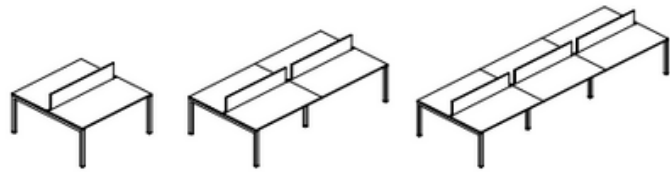

# Finiture | Finishes | Finitions | Acabados

## MEL

**Melaminico**  
Melamine | Mélaminé | Melaminico

TOP SCR MOD

|   |   |  |  |  |
|---|---|--|--|--|
|   |   |  |  |  |
| <b>Bianco rigato</b><br>Rippled effect white<br>Blanc avec rayures en sérigraphie Blanco rayado | <b>Grigio rigato</b><br>Rippled effect grey<br>Gris avec rayures en sérigraphie Gris rayado | <b>Nichel</b><br>Nickel<br>Nickel                            | <b>Cacao</b><br>Cocoa<br>Cacao                   | <b>Bianco</b><br>White<br>Blanc                            |
|   |   |  |  |  |
| <b>Talco</b><br>Talc<br>Talc  | <b>Ocra</b><br>Ochre<br>Ocre  | <b>Safari</b><br>Safari<br>Safari                            | <b>Noisette</b><br>Noisette<br>Noisette          | <b>Verde</b><br>Green<br>Vert                              |
|   |   |  |  |  |
| <b>Nero</b><br>Black<br>Noir  | <b>Blu notte</b><br>Night blue<br>Bleu nuit   | <b>Ardesia</b><br>Ardesia<br>Pizarra                         | <b>Rovere chiaro</b><br>Light oak<br>Chêne clair | <b>Rovere americano</b><br>American oak<br>Chêne américain |
|   |   |  |  |  |
| <b>Rovere grigio</b><br>Grey oak<br>Chêne gris  | <b>Rovere moro</b><br>Dark oak<br>Chêne foncé   | <b>Noce Canaletto</b><br>Canaletto Walnut<br>Noyer Canaletto | <b>Noce scuro</b><br>Dark walnut<br>Noyer foncé  |  |

## GOF

### Goffrato

Embossed | Gaufré | Lacado

SCR



**Moka**  
Mocha  
Moka  
Cafe



**Indaco**  
Indigo  
Indigo  
Azul Indigo



**Rubino**  
Ruby  
Rubis  
Rubi



**Cedro**  
Lime green  
Vert Cédrat  
Verde Cedro



**Argento**  
Silver  
Argent  
Plata

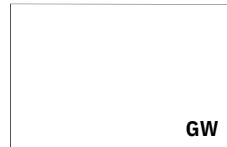

**Bianco**  
White  
Blanc  
Blanco

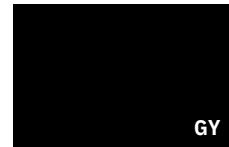

**Nero**  
Black  
Noir  
Negro



**Rosso "F"**  
Red "F"  
Rouge "F"  
Rojo "F"



**Arancione**  
Orange  
Orange  
Naranja



**Grigio scuro**  
Dark grey  
Gris foncé  
Gris oscuro



**Azzurro**  
Blue  
Bleu  
Azul



**Verde**  
Green  
Vert  
Verde

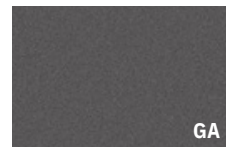

**Ardesia**  
Ardesia  
Ardesia  
Pizarra



**Noisette**  
Noisette  
Noisette  
Noisette

## MTC

### Metacrilato

Acrylic | Méthacrylate | Metacrilato

SCR

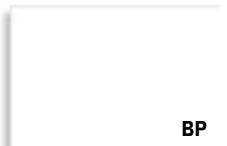

**Bianco opalino**  
Opaline white  
Blanc opalin  
Blanco opaco

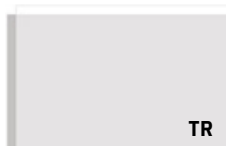

**Trasparente**  
Transparent  
Transparent  
Transparente



**Rosso trasparente**  
Red transparent  
Rouge transparent  
Rojo transparente



**Blu trasparente**  
Blue transparent  
Bleu transparent  
Azul transparente



**Bianco satinato**  
Satin-finish white  
Blanc satiné  
Blanco satinado



**Grigio fumè satinato**  
Satin-finish smoky grey  
Gris satiné  
Gris satinado



**Arancione satinato**  
Satin-finish orange  
Orange satiné  
Naranja satinado



**Blu satinato**  
Satin-finish blue  
Bleu satiné  
Azul satinado



**Verde satinato**  
Satin-finish green  
Vert satiné  
Verde satinado

## TES

### Tessuto

Fabric | Tissu | Tejido

SCR



**Beige**  
Beige  
Beige  
Beige

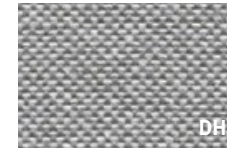

**Grigio chiaro**  
Light grey  
Gris clair  
Gris claro



**Ardesia**  
Ardesia  
Ardesia  
Pizarra



**Blu avio**  
Avio blue  
Bleu avio  
Azul avio

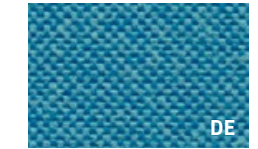

**Acquamarina**  
Aquamarine  
Aiugue-marine  
Aguamarina

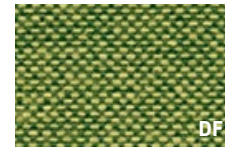

**Verde primavera**  
Spring green  
Vert printemps  
Verde primavera



**Salvia**  
Sage  
Sauge  
Salvia



**Arancio**  
Orange  
Orange  
Naranja



**Corallo**  
Coral  
Corail  
Coral

## EPX

### Epossidico

Epoxy | Époxy | Epoxi

STRU



**Bianco**  
White  
Blanc  
Blanco

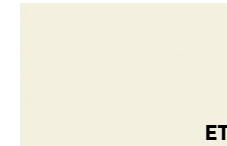

**Talco**  
Talco  
Talco  
Talco

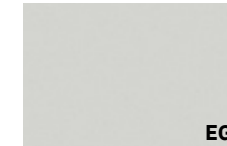

**Grigio**  
Grey  
Gris  
Gris



**Beige Arizona**  
Arizona beige  
Beige Arizona  
Beige Arizona



**Noisette**  
Noisette  
Noisette  
Noisette



**Safari**  
Safari  
Safari  
Safari

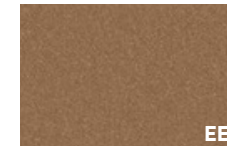

**Rame**  
Copper  
Cuivre  
Cobre

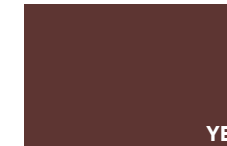

**Rosso Jaipur**  
Jaipur red  
Rouge Jaipur  
Rojo Jaipur

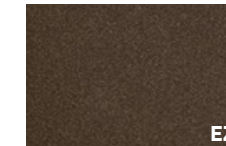

**Bronzo**  
Bronze  
Bronze  
Bronze



**Blu notte**  
Night blue  
Bleu nuit  
Azul noche

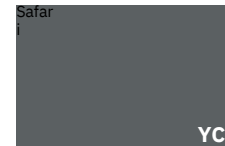

**Grigio Bromo**  
Bromo grey  
Gris Bromo  
Gris Bromo

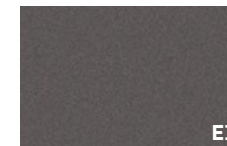

**Ardesia**  
Ardesia  
Ardesia  
Pizarra



**Verde Comodoro**  
Comodoro green  
Vert Comodoro  
Verde Comodoro



**Nero**  
Black  
Noir  
Negro

## Applicazioni finiture

Finish application | Application finitions | Aplicacion acabados



**TOP**  
Piano  
Top  
Plateau  
Sobre



**MOD**  
Modesty panel  
Modesty panel  
Voile de fond  
Faldón



**SCR**  
Screen  
Screen  
Écran  
Panel



**STRU**  
Struttura  
Structure  
Structure  
Structura

Le finiture contenute nella stampa sono puramente indicative e non sono di riferimento per le finiture del prodotto  
Due to the printing process, finishes shown in this document are for illustration only. The finish on the final item may differ slightly from the printed illustration. Les finitions contenues dans l'impression sont purement indicatives et ne sont pas pertinentes pour les finitions du produit.  
Los acabados contenidos en la impresión son puramente indicativos y no son de referencia para los suministros del producto

# Ambiente e sicurezza | Environment and safety | Environnement et sécurité | Medio ambiente y seguridad

**Ecologia** Auraa Design utilizza per i suoi prodotti e i suoi imballi materiali facilmente separabili e riciclabili.  
**Attestazione di prodotto** I prodotti Auraa Design sono stati sottoposti a prove prestazionali presso laboratori di prova accreditati. Copia dei rapporti di prova o delle attestazioni di conformità sono disponibili su richiesta. I prodotti Auraa Design soddisfano i requisiti LEED per il credito IEQ4.5 per i materiali a bassa emissione ed i requisiti ANSI/BIFMA X7.1-2011. Auraa Design dichiara di utilizzare pannelli a base di legno aventi un rilascio di formaldeide conforme alla classe E1 secondo il DM 10/10/2008. Auraa Design si impegna inoltre ad utilizzare materiali legnosi FSC e pannelli a base di legno con certificazione CARB2.

**Environment Auraa Design** products and packaging are made of recyclable materials.  
**Product certification Auraa Design** products have been subjected to performance tests at accredited testing laboratories. Copies of test reports or certificates of conformity are available on request. Auraa Design products meet the LEED requirements for IEQ4.5 credit for low emission materials and the ANSI/BIFMA X7.1-2011 requirements. Auraa Design declares to use wood-based panels with a formaldehyde release according to class E1 according to DM 10/10/2008. Auraa Design also undertakes to use FSC wood-based materials and CARB2- certified wood-based panels.

**Environnement** Auraa Design utilise des matériaux facilement séparables et recyclables pour ses produits et ses emballages.  
**Certification de produits** Les produits Auraa Design ont été soumis à des tests de performance dans des laboratoires accrédités. Des copies des rapports d'essais ou des certificats de conformité sont disponibles sur demande. Les produits Auraa Design répondent aux exigences LEED pour le crédit IEQ4.5 pour les matériaux à faibles émissions et aux exigences ANSI/BIFMA X7.1-2011. Auraa Design déclare utiliser des panneaux à base de bois avec un dégagement de formaldéhyde selon la classe E1 selon DM 10/10/2008. Auraa Design s'engage également à utiliser des matériaux à base de bois FSC et des panneaux à base de bois certifiés CARB2.

**Ecología** Auraa Design utiliza productos y embalajes en materiales fácilmente separables y reciclables.  
**Certificación de producto** Los productos Auraa Design han sido sometidos a pruebas de rendimiento en laboratorios de pruebas acreditados. Copias de los informes de las pruebas o certificados de conformidad están disponibles bajo petición. Los productos Auraa Design cumplen con los requisitos LEED para el crédito IEQ4.5 para materiales de baja emisión y los requisitos ANSI/BIFMA X7.1- 2011. Auraa Design declara utilizar paneles de madera con una emisión de formaldehído según la clase E1 según DM 10/10/2008. Auraa Design también se compromete a utilizar materiales a base de madera FSC y paneles a base de madera certificados por CARB2.

**Design**  
Filippon & Mirto Antonel

**Art direction**  
Mirto Antonel

AD/CACC/AG

**Le immagini dei prodotti visibili all'interno di questo catalogo sono inserite a scopo puramente indicativo**  
The images of the products visible in this catalogue are included for information purposes only  
Les images des produits visibles dans ce catalogue sont incluses à titre informatif uniquement  
Las imágenes de los productos visibles en este catálogo se incluyen sólo con fines informativos

# aura design



Hub Spaces, 582 Honeypot Lane, Stanmore, HA7 1JS, UK  
[www.auraadesign.co.uk](http://www.auraadesign.co.uk)  
020 3915 8008  
[info@auraadesign.co.uk](mailto:info@auraadesign.co.uk)