

aura  
design

# Dalon

---





# Dalon

Kolekcja Dalon oferuje bogatą stylistykę, łącząc ze sobą bogactwo szlachetnych materiałów, niedoścignione wykonanie i ergonomię użytkowania. Ekskluzywna gama nieoczywistych komponentów, pozwala na nadanie wnętrzu indywidualnego charakteru oraz spersonalizowania według własnych potrzeb. Dalon rozpieszczy użytkowników elegancją, dbałością o szczegóły oraz innowacjami.

Dalon – dla tych, co oczekują więcej.

*Dalon offers unmet style, combining exquisite materials, finest craftsmanship and ergonomics. An exclusive range of components allows you to give the interior an individual character and personalize it according to your needs. Dalon spoils users with elegance, attention to detail and innovation.*

*Dalon – for those who demand more.*



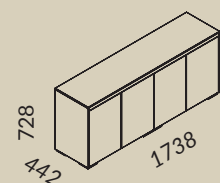
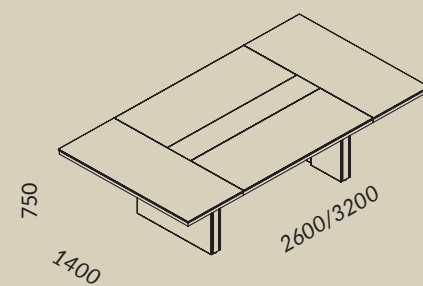
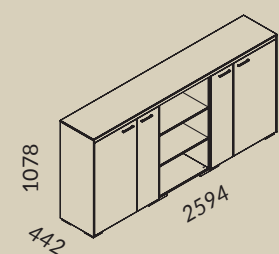

N06  
Fornir  
DĄB FLADER  
Veneer  
FLADER OAK

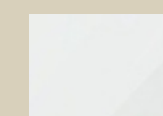

Szko  
BIAŁE LACOBEL  
Glass  
WHITE LACOBEL



U1  
Melamina  
BIAŁY  
Melamine  
WHITE



Akcent  
ALUMINIUM  
SZCZOTKOWANE  
Decorative strip  
BRUSHED ALUMINUM

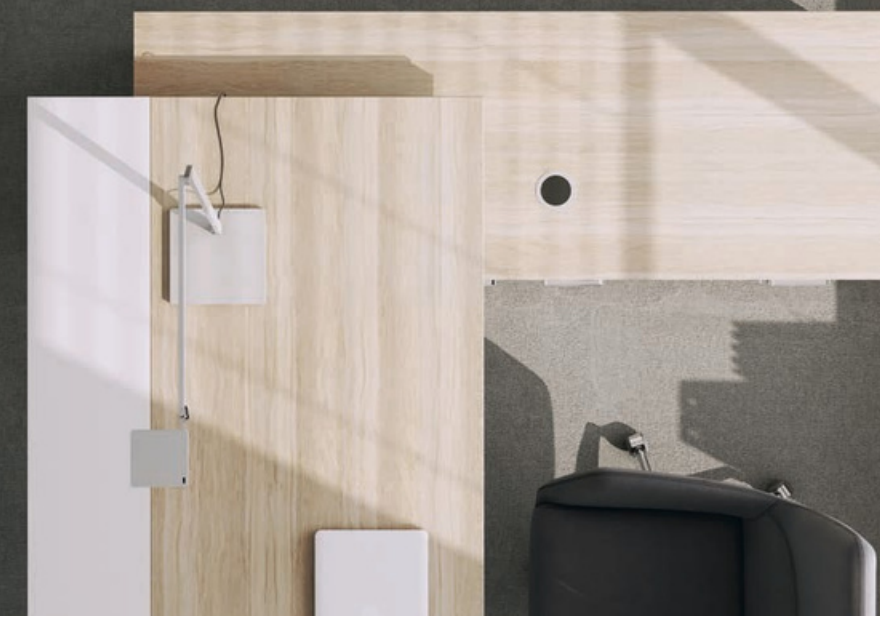



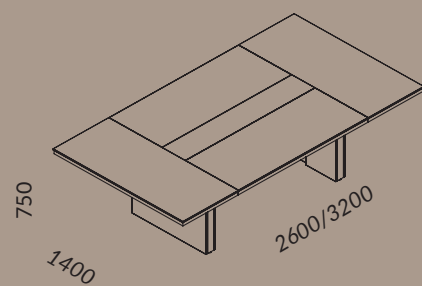

DR1  
Melamina 3D  
ORZECH MADISON  
3D Melamine  
WALNUT MADISON

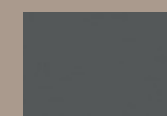

U11  
Melamina  
GRAFIT  
Melamine  
GRAPHITE



Akcent  
ALUMINIUM  
SZCZOTKOWANE  
Decorative strip  
BRUSHED ALUMINIUM

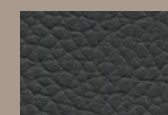

LE2  
Skóra naturalna  
GRAFITOWA  
Natural leather  
GRAPHITE

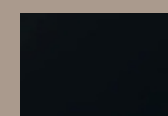

Szkło  
CZARNE LACOBEL  
Glass  
BLACK LACOBEL









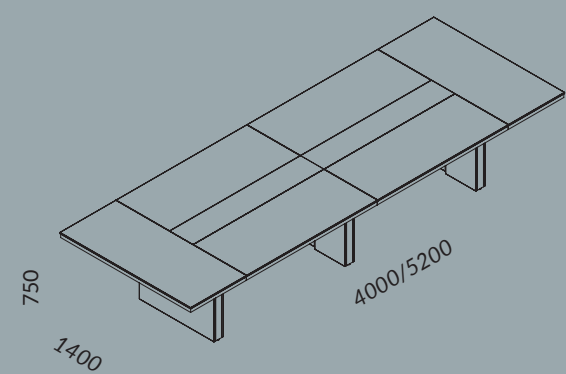

ST2  
Kamień polerowany NOIR  
DESIR  
Polished stone  
NOIR DESIR

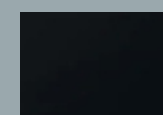

Szkoło  
CZARNE  
LACOBEL Glass  
BLACK LACOBEL



U10  
Melamina  
BEZOWY KASZMIR  
Melamine  
BEIGE CASHMERE



Akcent  
ALUMINIUM  
SZCZOTKOWANE  
Decorative strip  
BRUSHED ALUMINUM







auraa  
design

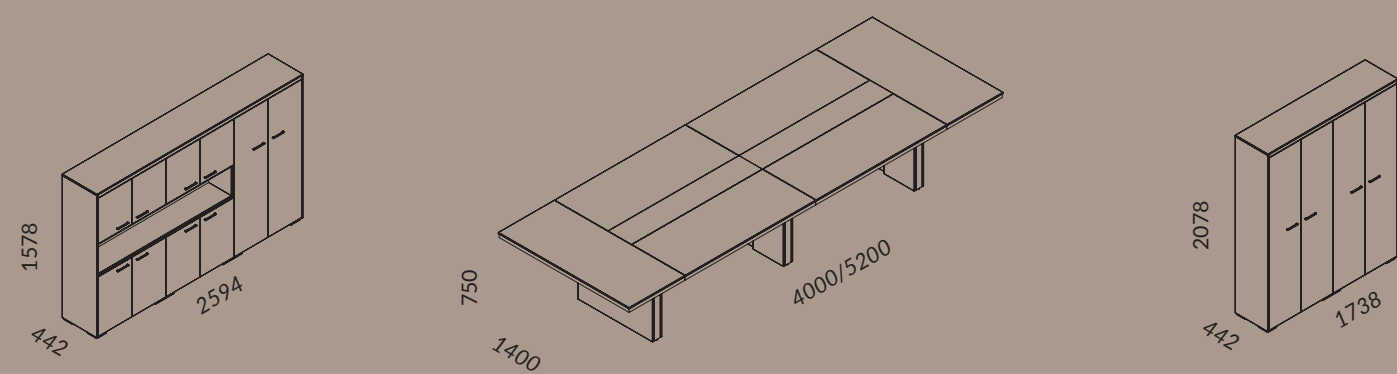

DR4  
Melamina 3D  
DĄB GÓRSKI SZARY 3D  
Melamine SCANDINAVIAN  
OAK

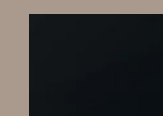

Szkło  
CZARNE  
LACOBEL Glass  
BLACK LACOBEL



U1  
Melamina  
BIAŁY  
Melamine  
WHITE



Akcent  
ALUMINIUM  
SZCZOTKOWANE  
Decorative strip  
BRUSHED ALUMINIUM





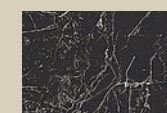
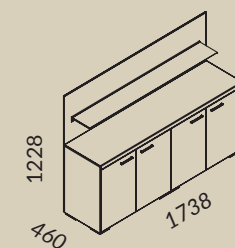
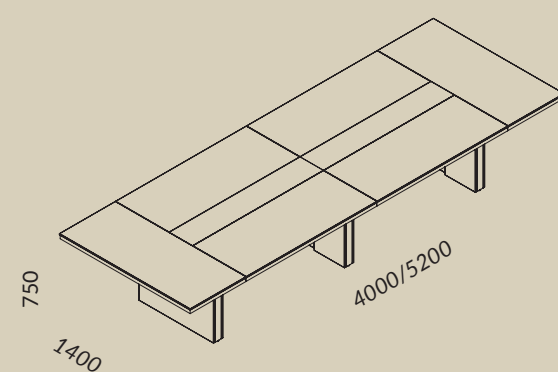

ST1  
Kamień polerowany NERO  
GRECO  
Polished stone  
NERO GRECO

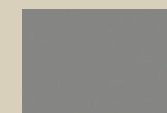

U6  
Melamina  
SZARY PLATYNOWY  
Melamine  
PLATINUM GREY



Akcent  
ALUMINIUM  
SZCZOTKOWANE  
Decorative strip  
BRUSHED ALUMINUM

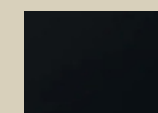

Sztko  
CZARNE  
LACOBEL Glass  
BLACK LACOBEL

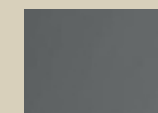

Sztko  
CZARNE  
OPTI Glass  
BLACK OPTI





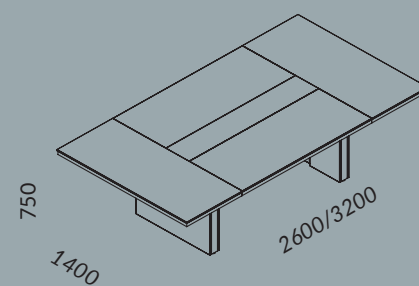
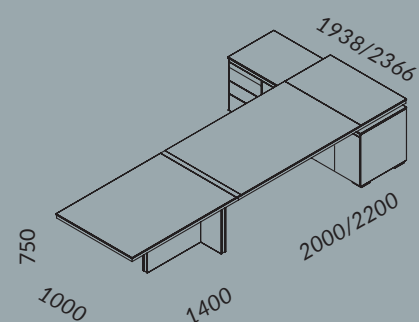
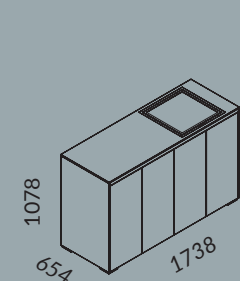

ST3  
Kamień polerowany  
BIANCO VENATO Polished  
stone  
BIANCO VENATO



U10  
Melamina  
BEZOWY KASZMIR  
Melamine  
BEIGE CASHMERE



Akcent  
ALUMINIUM  
SZCZOTKOWANE  
Decorative strip  
BRUSHED ALUMINIUM

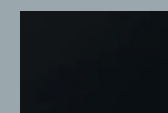

Szko  
CZARNE LACOBEL  
Glass  
BLACK LACOBEL





## colors

### BLAT / TOP SURFACE

Fornir / Veneer  
Melamina 3D / 3D Melamine  
Kamień polerowany / Polished stone

### NOGA WEWNĘTRZNA / LEG INNER SIDE

Melamina / Melamine

### STELAŻ / FRAME

Metal / Metal

### FRONTY WITRYN I SZAF / FRONT

Fornir / Veneer  
Melamina 3D / 3D Melamine  
Kamień polerowany / Polished stone  
Melamina / Melamine  
Szkło Lacobel / Glass Lacobel

### WNĘKA / NICHE

Szkło Lacobel / Glass Lacobel

### PÓŁKA WITRYN Y / SHOWCASE SHELF

Szkło Opti / Glass Opti

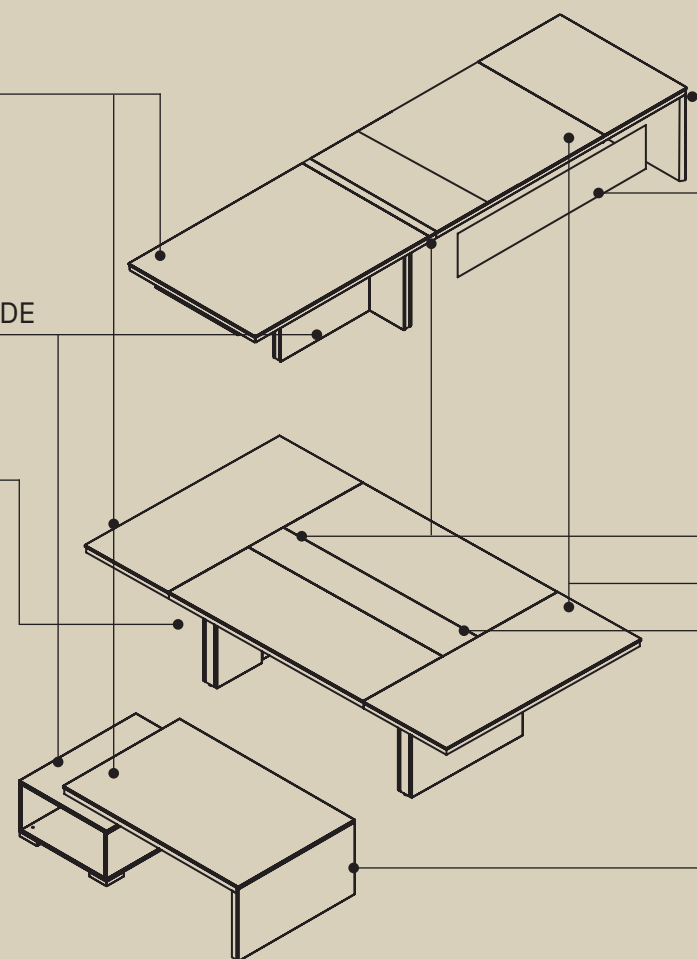

### AKCENT / DECORATIVE STRIP

### ZABUDOWA / MODESTY PANEL

Szkło Lacobel / Glass Lacobel  
Fornir / Veneer  
Melamina 3D / 3D Melamine  
Kamień polerowany / Polished stone

### WSTAWKI DO BLATÓW / TOP INSERTS

Szkło Lacobel / Glass Lacobel  
Skóra naturalna / Natural leather  
Melamina / Melamine\*

### NOGA ZEWNĘTRZNA / LEG OUTER SIDE

Fornir / Veneer  
Melamina 3D / 3D Melamine  
Kamień polerowany / Polished stone

### KORPUS WITRYN I SZAF / CARCASS

Melamina / Melamine

### OKŁADZINA GÓRNA / UPPER COVERS

Fornir / Veneer  
Melamina 3D / 3D  
Melamine Szkło Lacobel /  
Glass Lacobel

### OKŁADZINY BOCZNE / SIDE COVERS

Fornir / Veneer  
Melamina 3D / 3D Melamine

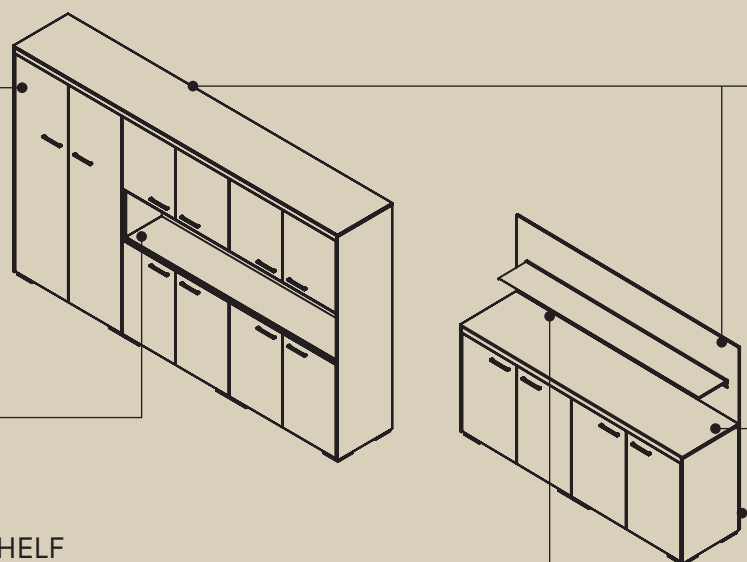

### FORNIR / VENEER

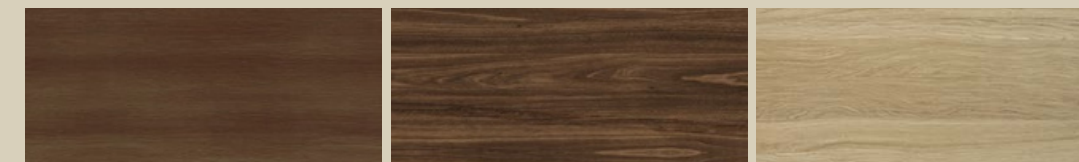

N04 Machoń Burundi / Burundi Mahogany  
N05 Palisander Brazylijski / Brazilian Rosewood  
N06 Dąb Flader / Flader Oak

### MELAMINA 3D / 3D MELAMINE



DN1 Tectona Srebrzysta / Silver Teak  
DN2 Wiąz Vermont / Vermont Elm  
DR1 Orzech Madison / Madison Walnut  
DR2 Kasztan Fumo / Fumo Chestnut  
DR4 Dąb Górski Szary / Scandinavian Oak

### MELAMINA KAMIEŃ POLEROWANY / MELAMINE/POLISHED STONE

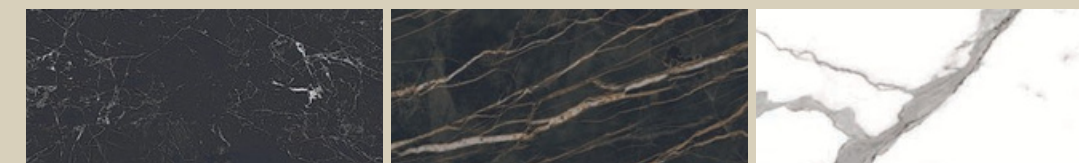

ST1 Nero Greco / Nero Greco  
ST2 Noir Desir / Noir Desir  
ST3 Bianco Venato / Bianco Venato

### METAL / METAL



U1 Biały / White  
U2 Popiel / Grey  
U6 Szary Platynowy / Platinum Grey  
U10 Beżowy Kaszmir / Beige Cashmere  
U11 Grafit / Graphite

### SZKŁO LACOBEL / GLASS LACOBEL

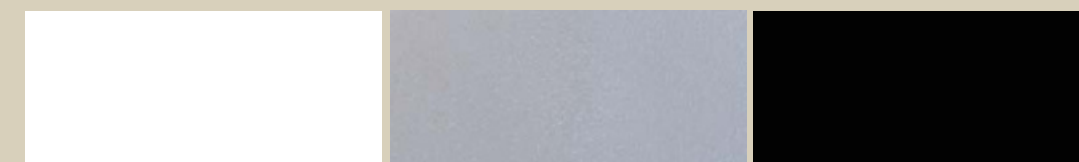

M02 Biały / White  
M01 Aluminium / Aluminium  
M04 Czarny / Black

### SKÓRA NATURALNA / NATURAL LEATHER

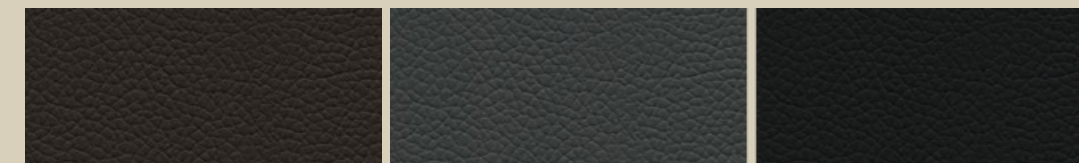

LE1 Brązowa / Brown  
LE2 Grafitowa / Graphite  
LE3 Czarna / Black

### AKCENT / DECORATIVE STRIP



Aluminium  
Szczotkowane / Brushed  
Aluminum

### SZKŁO OPTI / GLASS OPTI

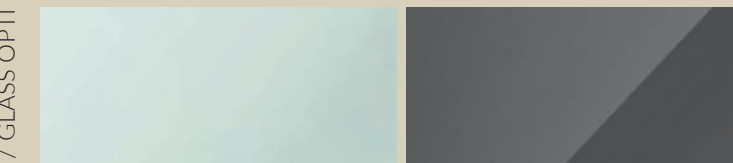

Białe Opti / White Opti  
Czarne Opti / BlackOpti



**BIURKA GABINETOWE PROSTE / RECTANGULAR DESKS**

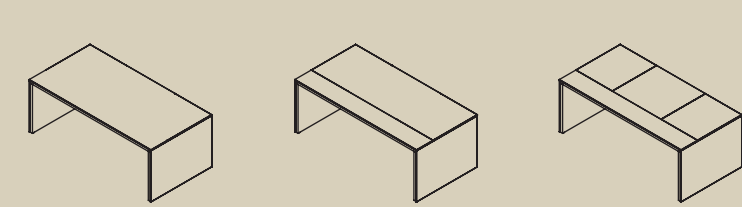

AR 03 2000/1000/750 AR 13 2000/1000/750 AR 23 2000/1000/750  
AR 04 2200/1000/750 AR 14 2200/1000/750 AR 24 2200/1000/750

**BIURKA GABINETOWE WSPARTE NA SZAFCE / DESKS SUPPORTED ON CABINET\***

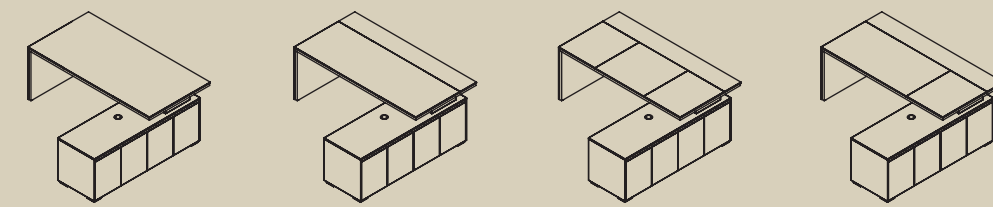

AR 07 2000/1000/750 AR 17 2000/1000/750 AR 27 2000/1000/750 AR 37 2000/1000/750  
AR 08 2200/1000/750 AR 18 2200/1000/750 AR 28 2200/1000/750 AR 38 2200/1000/750

**BIURKA Z PRZYSTAWKĄ / DESKS WITH A CONFERENCE EXTENSION**

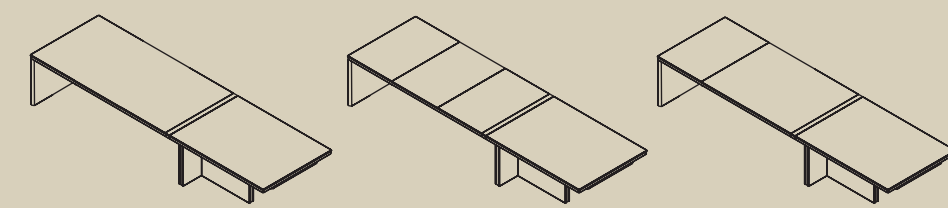

AR 69 3400/1000/750 AR 19 3400/1000/750 AR 29 3400/1000/750  
AR 60 3600/1000/750 AR 10 3600/1000/750 AR 20 3600/1000/750

**BIURKA ELEKTRYCZNE / DESKS WITH ELECTRIC HEIGHT ADJUSTMENT \***

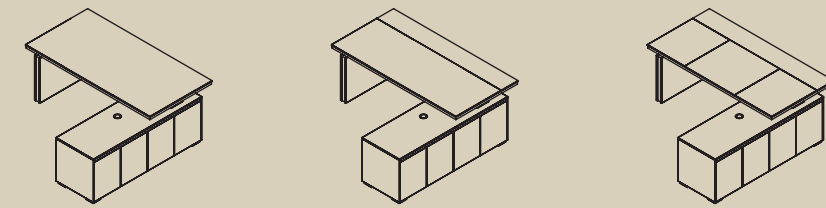

AE 03 2000/1000/750-1250 AE 13 2000/1000/750-1250 AE 23 2000/1000/750-1250  
AE 04 2200/1000/750-1250 AE 14 2200/1000/750-1250 AE 24 2200/1000/750-1250

**BIURKA Z PRZYSTAWKĄ WSPARTE NA SZAFCE / DESKS WITH A EXTENSION SUPPORTED ON CABINETS\***

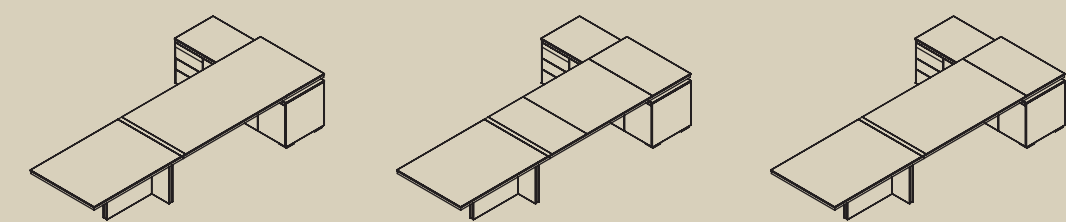

AR 39 3400/1000/750 AR 49 3400/1000/750 AR 59 3400/1000/750  
AR 30 3600/1000/750 AR 40 3600/1000/750 AR 50 3600/1000/750

**SZAFKI PODBIURKOWE / UNDERDESK CABINETS**



AW 01 1738/604/632 AW 02 2166/604/632

**ZABUDOWA / MODESTY PANELS**

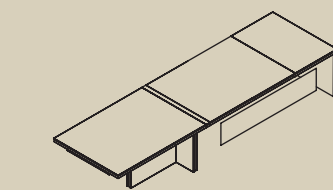

ZP 21 1800 ZP 22 1450 ZP 23 1250

**KONTENERY MOBILNE / MOBILE PEDESTALS**

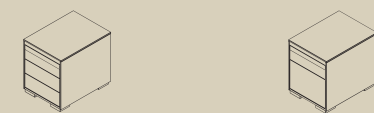

AK 01 454/622/557 AK 02 454/622/557

**STOLIKI KAWOWE / COFFE TABLES**



AT 81 1000/800/450 AT 71 1000/700/450  
AT 82 1200/800/450 AT 72 1200/700/450  
AT 83 1400/800/450 AT 73 1400/700/450

**STOŁY KONFERENCYJNE / CONFERENCE TABLES**

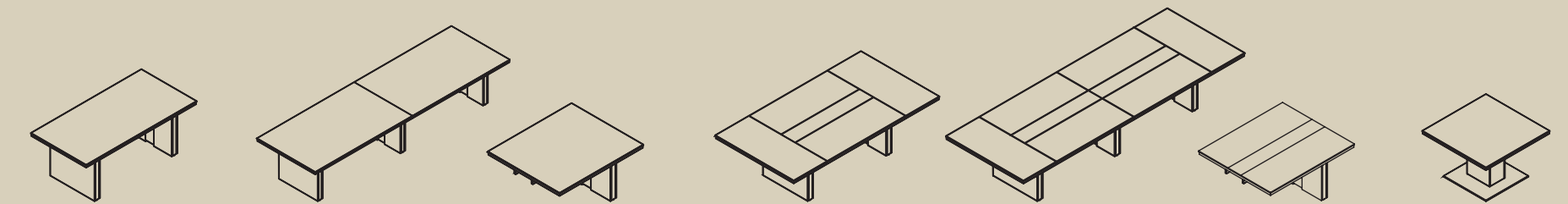

AT 11 2000/1000/750 AT 21 4000/1200/750 AT 22 1400/1200/750 AT 31 2600/1400/750 AT 41 4000/1400/750 AT 22 1400/1200/750  
AT 12 2400/1000/750 AT 23 2000/1200/750 AT 32 3200/1400/750 AT 42 5200/1400/750 AT 23 2000/1200/750 AT 61 1200/1200/750

**WITRYNY / SHOWCASES**

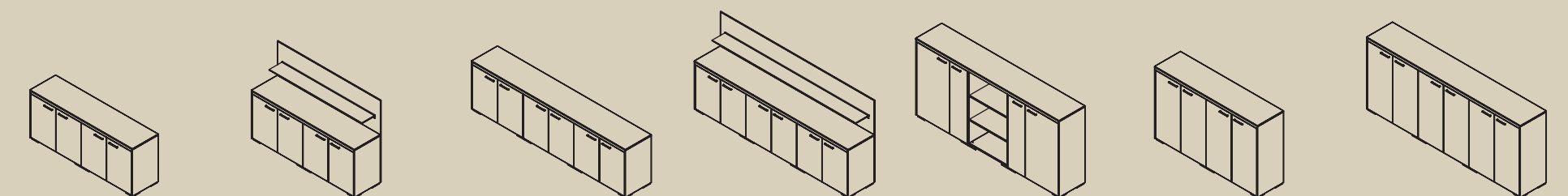

AC 11 1738/442/728 AC 12 1738/460/1228 AC 13 2594/442/728 AC 14 2594/460/1228 AC 01 2594/442/1078 AC 21 1738/442/1078 AC 22 2594/442/1078

**WITRYNY / SHOWCASES**

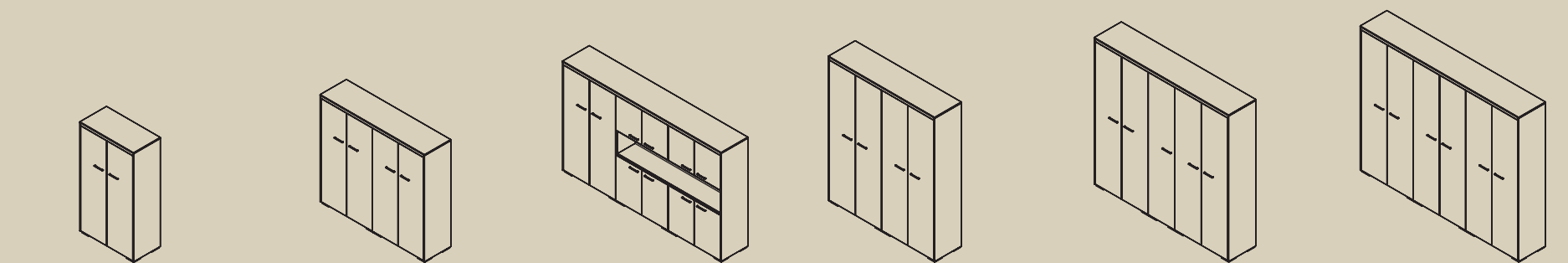

AC 31 882/442/1578 AC 32 1738/442/1578 AC 33 2594/442/1578 AC 41 1738/442/2078 AC 45 2166/442/2078 AC 43 2594/442/2078

**SZAFKA TLEWIZYJNA / TV CABINET**

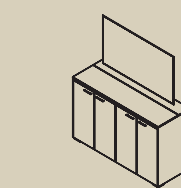

AC 51 1738/442/1078

**BARKI / MINIBARS**



AC 61 1738/654/1078 AC 62 2594/654/1078



## accessories & functionality



**PILOT DO BIUREK ELEKTRYCZNYCH /**  
PILOT FOR DESK CONTROL



**\*PRZELOTKA CHROMOWANA KABLOWA /PILOT DO RYGLOWANIA ZAMKÓW /**  
CHROMED CABLE OUTLET/REMOTE CONTROL FOR LOCK  
OPERATION



**UCHWYT (OPCJA BEZ DOPŁATY)/**  
HANDLE (OPTION WITHOUT  
SURCHARGE)



**\* MEDIAPORT /**  
MEDIAPORT



**ŁADOWARKA INDUKCYJNA /**  
INDUCTIVE CHARGER



**PRZEGRODY DO SZUFLAD**  
**W KONTENERZE MOBILNYM /**  
DRAWER DIVIDERS IN PEDESTALS



**UKOŚNE PRZEGRODY DO SZUFLAD**  
**W KONTENERZE MOBILNYM /**  
DIAGONAL FILING STORAGE IN  
PEDESTALS



# auraa design



Hub Spaces, 582 Honeypot Lane, Stanmore, HA7 1JS, UK  
[www.auraaesign.co.uk](http://www.auraaesign.co.uk)  
020 3915 8008  
[info@auraaesign.co.uk](mailto:info@auraaesign.co.uk)