

aura
design

Carsyn



Pedestals Carsyn



STRUCTURE

- Chipboard coated on both sides with melamine resin with increased durability - 1st class.
- Chipboard with reduced formaldehyde emission, E1 standard.
- Side edges finished with 2 mm thick ABS plastic edge with 3 mm radius.
- Carcass, floor and front are made of 18 mm thick chipboard.
- Top made of 25 mm thick board as standard.
- Top made of 18 mm thick board as an option pedestal 7 mm lower.

EQUIPMENT

DRAWERS

- Metal drawer on slides with soft close automatic mechanism.
- Drawer on extra castor.
- Metal sheet mounted on the right, possibility to mount it on the left.
- 80% drawer extension slide as standard, 100% extension slide as an option.

LOCK

- Central lock with removable cylinder.
- Two numbered keys (one foldable key).
- Possibility to choose identical lock as in the cabinets of your choice, see technical description of cabinets.

ADDITIONAL INFORMATION

- Carsyn pedestals are equipped with metal drawers that can be complemented by accessories such as traverse, longitude and diagonal dividers, pencil tray or suspension files insert and metal drawers.
- Possibility to manage cables through the pedestal carcass (2 outlets, cable clamp) as an option with a surcharge
- Add-on units dedicated to Carsyn pedestals in 3 options.



Carsyn add-on pedestal

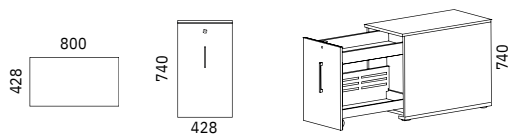

Carsyn underdesk pedestal

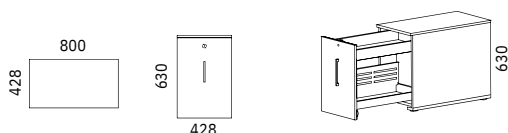

Carsyn open add-on unit 10H

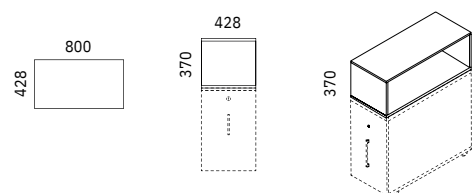

Carsyn high pedestal

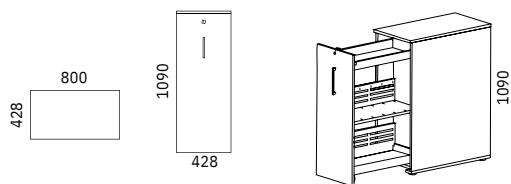

Carsyn high pedestal with inside drawer

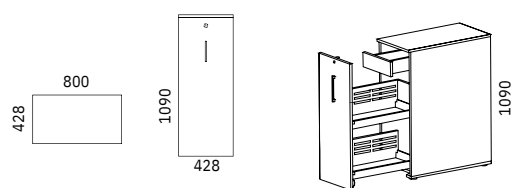

Pedestals / Equipment

Lock

Central lock with removable cylinder and two numbered keys, one foldable key as standard.

Possibility to choose identical lock as in the cabinets of your choice.

Handles

TOP pedestals are equipped with handlebars. Pedestals with tambour doors and Carsyn pedestals are equipped with B1 handles as standard. It is possible to change the handles.

SPACING : 128 mm

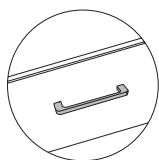

HANDLE A1



HANDLE B1

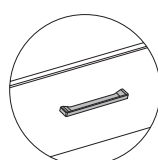

HANDLE C1

SPACING : 192 mm

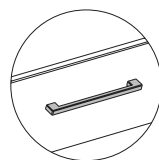

HANDLE Z1

SPACING : 64 mm

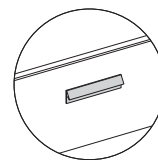

HANDLE V1

Drawers

- Metal and composite black drawers, 500 mm or 700 mm long suitable for transverse, longitudinal and diagonal dividers.
- All drawers (except TOP Plus pencil drawer) are equipped with ball runners.
- Slides with soft close automatic mechanism are equipped with decelerating function and automatic self closing mechanism.
- Soft close automatic mechanism is equipped with cylindrical roller bearings and toothed belt. This helps stabilize the drawers when pulled out and loaded.
- 200 N. All drawers are equipped with a safety mechanism, preventing from simultaneous opening of more than one drawer.
- 1HE pencil drawers are equipped with 100% extension slide, 2 and 3HE drawers are equipped with 80% extension slide. Standard extension of 6HE drawers depends on the pedestal model (see information below). Max load: 200 N.
- 6HE pedestals with drawers are equipped with a file hanger insert as standard.

Drawer accessories

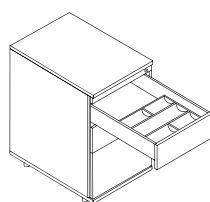

PENCIL TRAY DRAWER

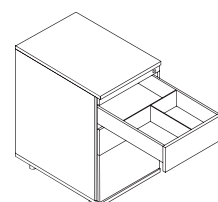

TRAVERSE AND LONGITUDINAL DIVIDERS

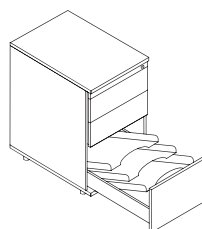

DIAGONAL DIVIDERS

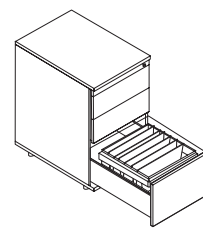

SUSPENSION FILES DRAWER

Pedestals / Colours

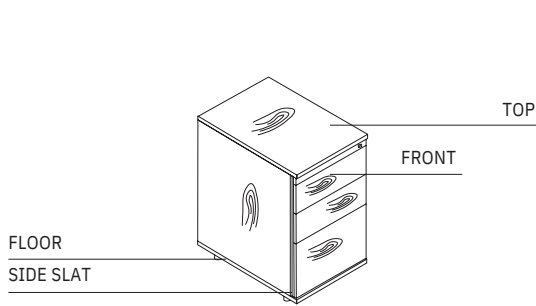

TOP pedestals

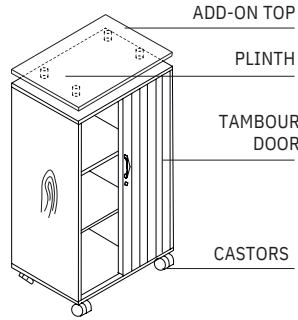

Pedestal with tambour door

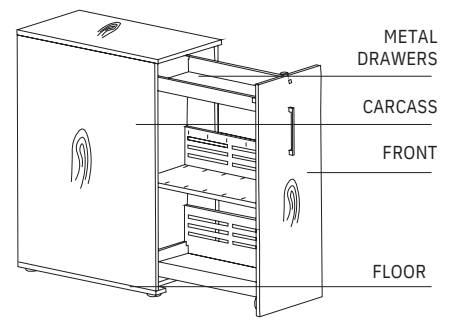

Carsyn pedestals

			Carcass	Floor	Top	Metal drawers	Front	Add-on Top	Plinth	Tambour door	Side slat	Castors	
STANDARD	Melamine UNI	STD 1 White	•	•	•		•	•					
		STD 2 High Gloss White					•	•					
		STD 3 Gray	•	•	•		•	•					
		STD 4 Beige	•	•	•		•	•					
		STD 5 Norwegian Green	•	•	•		•	•					
		STD 6 Navy Blue	•	•	•		•	•					
		STD 7 Graphite	•	•	•		•	•					
		STD 8 Black	•	•	•		•	•					
	Melamine	STD 10 Acacia	•	•	•		•	•	•				
		STD 11 European Maple	•	•	•		•	•	•				
		STD 12 Napolitano Oak	•	•	•		•	•	•				
		STD 13 Gray Spruce	•	•	•		•	•	•				
		STD 14 American Oak	•	•	•		•	•	•				
		STD 15 Natural Oaky	•	•	•		•	•	•				
		STD 16 Cherry Havana	•	•	•		•	•	•				
		STD 17 Walnut Brown	•	•	•		•	•	•				
		TREND*	Melamine	TRD 1 Blush	•	•	•		•	•			
TRD 2 Claret	•			•	•		•	•					
TRD 3 Dark Turquoise	•			•	•		•	•					
TRD 11 Stark Oak	•			•	•		•	•					
TRD 12 Flamed Oak	•			•	•		•	•					
STANDARD	Metal	M 02 White							•				
		M 01 Aluminium							•				
		M 03 Beige							•				
		M 05 Graphite							•				
		M 04 Black				•			•				
TREND*	Metal	M 06 Sunny Beige							•				
		M 09 Dirty Pink							•				
		M 08 Ginger							•				
		M 07 Faded Turquoise							•				
STANDARD	ABS	Black									•	•	
		RL 01 White									•		
	Tambour doors	RL 02 Silver									•		
Metal		Black						•					

Melamine

① STANDARD



② TREND

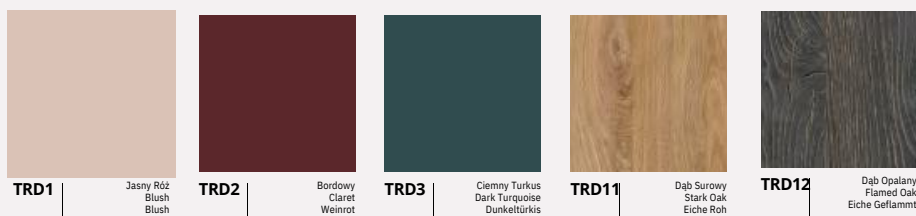

Metals

① STANDARD

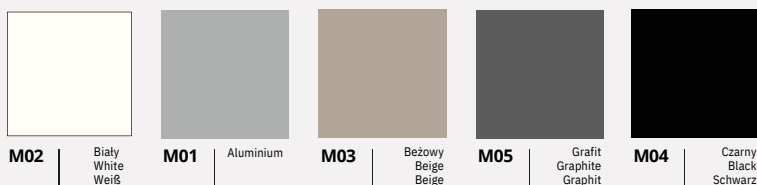

② TREND

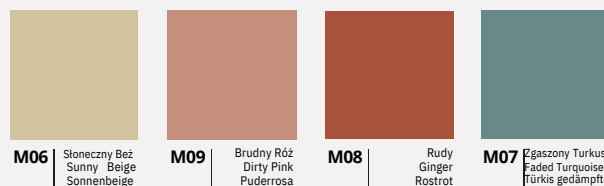

Fabrics

100% Polyester
100.000 Martindale cycles

① CALDO
Select by Lech

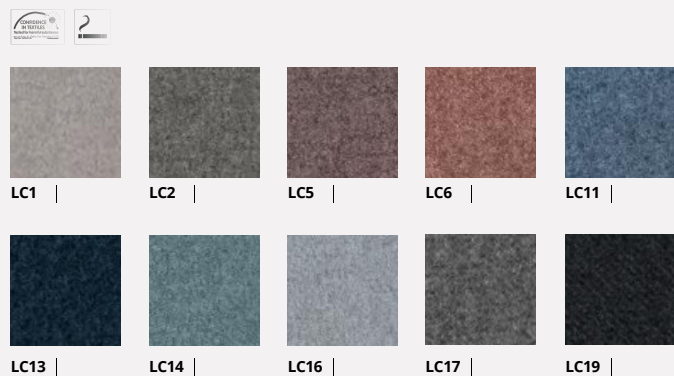

100 % Recycled Polyester 67.000
Martindale cycles

① TERRA
Select by Lech

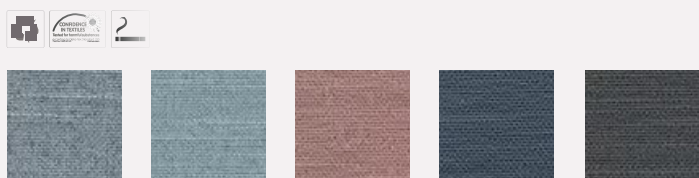

95% Virgin Wool, 5% Poliamid
100.000 Martindale cycles

② SYNERGY
Camira



aura design



Hub Spaces, 582 Honeypot Lane, Stanmore, HA7 1JS, UK
www.auraadesign.co.uk
020 3915 8008
info@auraadesign.co.uk