

# Brawvo

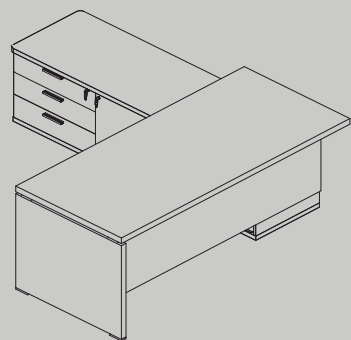

---

direzionali | executive | mobilier de direction | ejecutivos

auraa  
design

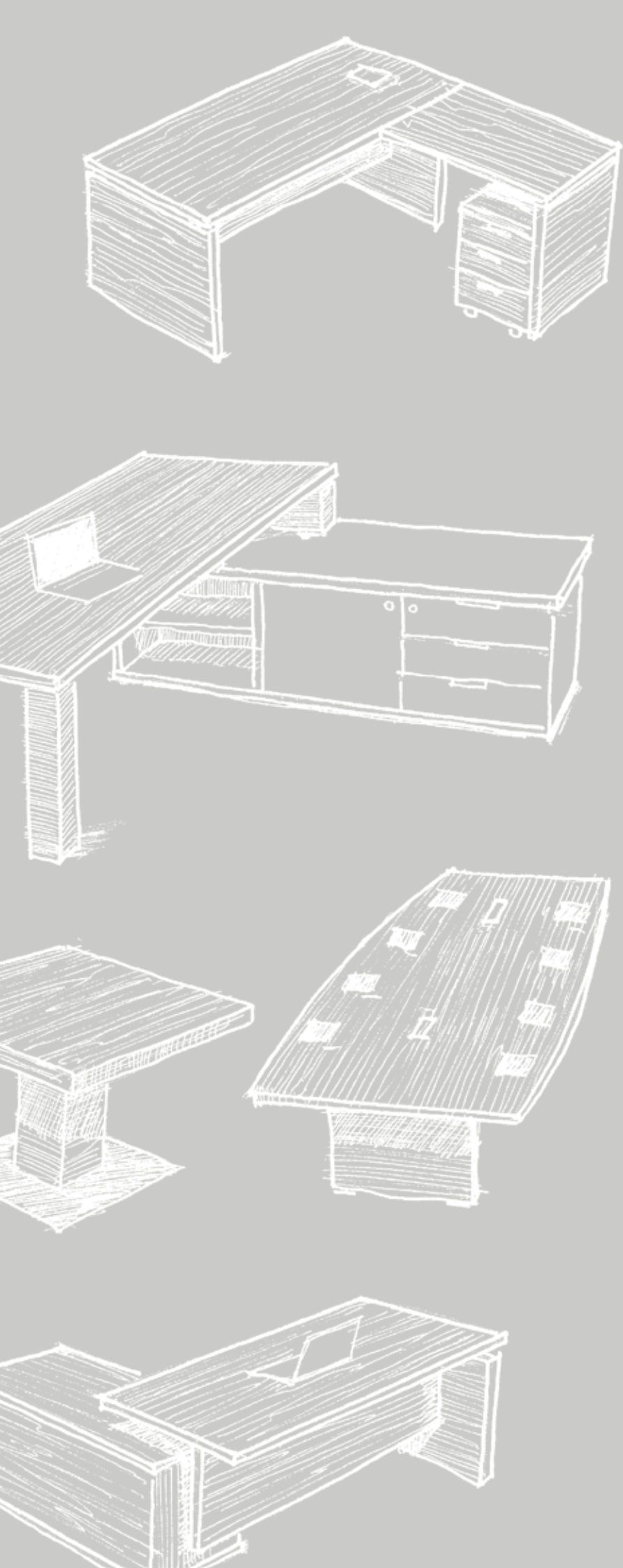

## Abbiamo rinnovato un classico bestseller

inserendo nuove soluzioni e combinazioni  
di finiture.

We have renewed a classic bestseller  
by introducing new solutions and  
combinations of finishes.

Nous avons renouvelé un best-seller en  
intégrant de nouvelles solutions et  
combinaisons de finitions.

Hemos renovado un clásico introduciendo  
nuevas soluciones y combinaciones de  
acabados.

Bravvo



## **/contenitori strutturali**

Al sistema direzionale Bravvo, caratterizzato da gambe pannellate che sostengono piani lavoro di spessore 40 mm, è stato abbinato un nuovo contenitore strutturale con vano a giorno, anta scorrevole, vano porta CPU e cassetiera tre cassetti o cassetto classificatore. Il contenitore prevede una doppia schiena per il transito verticale dei cavi.

**/structural storage** Bravvo managerial system, characterised by panel legs that support 40 mm thick worktops, has been combined with new structural storage with an open compartment, sliding door, CPU compartment and a choice of drawers. The storage features a false back to accommodate cables.

**/rangements structurels** au système exécutif Bravvo, caractérisés par des pieds-panneaux qui supportent des plans de travail épais de 40 mm. un nouveau rangement structurel a été combiné avec un compartiment ouvert, une porte coulissante, un compartiment pour CPU et un module à trois tiroirs ou un tiroir de classement vertical. Le module de rangement a un double dos pour le passage vertical des câbles.

**/muebles de servicio** la colección ejecutiva Bravvo se compone de patas-panel que soportan sobres de trabajo de 40 mm de grosor. Hemos combinado un nuevo mueble auxiliar estructural con vano abierto, puerta corredera, soporte CPU y cajonera 3 cajones o 1 cajon con archivador. El mueble está equipado con vano técnico para acceso al compartimiento interior para la subida de los cables.



Bravvo





**/meeting tables** a new family of meeting tables has been added. Square and rectangular tables with panel legs or round bases. To suite with the desk design we offer a folded column base, that also allows access for cables from floor to top if required. This rests on a painted steel base.

**/tables de réunion** une nouvelle famille de tables de réunion, carrées ou rectangulaires, a été ajoutée aux tables avec pieds panneaux et bases rondes en métal. Ces tables se caractérisent par un pied de colonne en tôle pliée et adaptable au passage vertical du câblage grâce à des rabats spéciaux. La colonne repose solidement sur une plaque métallique peinte.

**/mesas de reuniones** hemos adjuntado una nueva línea de mesas de reuniones. Las nuevas mesas de reunión pueden ser cuadradas o rectangulares y se caracterizan por la columna cuadrada que soporta el tablero realizada en "folding" y adaptable al tránsito vertical del cableado gracias a los pasacables. La columna apoya sobre base metálica cuadrada realizada por una pletina de metal pintada.

---

### **/tavoli riunione**

Una nuova famiglia di tavoli riunione, quadrati o rettangolari, si è aggiunta ai tavoli con gambe pannellate e basi metalliche rotonde. Sono caratterizzati da un basamento a colonna realizzata in folding e adattabile al passaggio verticale del cablaggio grazie ad appositi passacavi. La colonna poggia solidamente su una piastra in metallo verniciato.



Bravvo 6



Bravvo 1



Bravvo 1





Bravvo 1





Bravvo 1





### **/flessibilità**

Abbinamenti di diversi materiali e complementi, permettono di moltiplicare le possibili soluzioni d'arredo. L'accostamento tra le essenze del legno e gli inserti in cuoio conferiscono alla scrivania un prestigio particolare. L'utilizzo di credenze sospese con dettagli in metallo impreziosisce tutto l'ambiente.

***flexibility** being able to integrate different materials raises the design. The combination of wood, metal and leather give Bravo a particular prestige. Using suspended sideboards with painted metal detail enriches the whole environment.*

***flexibilité** favorisé par la possibilité de puiser dans différents matériaux et compléments, permet de diversifier le niveau du mobilier. Le choix des essences de bois combinées aux inserts en cuir confèrent au bureau une élégance particulière. L'utilisation de crédences suspendues avec des détails métalliques, rend tout l'environnement plus élégant.*

***flexibilidad** combinaciones de diferentes materiales y complementos permiten de incrementar las oportunidades. La combinación de madera y cuero confieren al escritorio un prestigio particular. El uso de contenedores suspendidos con detalles en metal embellece el resultado.*



Bravvo



30  
wed

---

### /vetro

Il piani in vetro di Bravvo presentano una cornice in alluminio perimetrale di spessore 40 mm che può essere anodizzata/spazzolata o verniciata a polveri epossidiche. I vetri sono disponibili sia nella versione retro-laccata che in quella antimpronta. Su richiesta si possono applicare gli sportelli passacavi anche sui piani in vetro.

## Bravvo 9



**Iglass** Bravo glass tops have a 40 mm thick perimeter aluminium frame that can be anodized/brushed or epoxy powder coated. Glass is available in both back-lacquered and anti-finger versions. On request it is also possible to apply the top accesses to the glass tops.

**Iverre** les plateaux en verre d'Odéon sont dotés d'un cadre en aluminium pouvant être anodisé/brossé ou vernis poudres époxy. Ils ont une épaisseur de 40 mm d'épaisseur. Les verres sont disponibles dans les versions rétro-laquées et anti-taches. Sur demande, les accès passe-câbles peuvent également être installés sur les étagères en verre.

**Ividrio** los tableros en vidrio tienen un borde de aluminio extruido 40 mm de grosor en acabado brillante/anodizado o pintado epoxi. Los vidrios están disponibles en cristal retro lacado y posible tratamiento antihuella en la parte superior. A petición los tableros en vidrio pueden equiparse con pasacables.





Bravvo

# Bravvo 4

## /elettrificazione

Ogni tavolo riunione Bravvo, a seconda della sua struttura, prevede una soluzione per la gestione del cablaggio. Nei tavoli con basamenti metallici rotondi, il flip-top supporta una vasca per sostenere le prese e si completa con una vertebra per il transito verticale dei cavi.



**/electrification** each Bravvo meeting table, depending on its structure, provides a solution for wiring management. In tables with round metal bases grommets support a basket to hold sockets and is completed with a cable duct for cables vertical transit.

**/électrification** chaque table de réunion Bravvo, selon sa structure, offre une solution pour la gestion des câbles. Les tables avec des pieds métalliques ronds, le flip-top offre un accès à une corbeille qui soutient les prises. Une vertèbre gère le transit vertical des câbles.

**/electrificación** cada mesa de reunión contempla una solución para la electrificación en función de la estructura de la mesa. En las mesas con bases metálicas circulares una cesta para los accesorios se engancha al flip top y se completa con una vertebra para electrificación vertical.



Bravvo 2

# Bravvo 2

## /tavoli modulari

I tavoli modulari sono realizzati con gambe pannellate collegate tra loro da una trave strutturale in alluminio. I tavoli possono essere estesi a qualsiasi dimensione e sono disponibili sia in melaminico che in essenza di legno.

*/modular tables modular tables are made with panel legs connected linked by an aluminium structural beam. Tables can be extended to any size and are available both in melamine and wood veneer.*

*/tables modulaires les tables modulaires sont fabriquées avec des pieds panneaux reliés entre eux par une poutre structurelle en aluminium. Les tables peuvent s'adapter à n'importe quelle taille et elles sont disponibles à la fois en mélamine et en placage de bois.*

*/mesas modulares en las mesas de reunión modulares las patas están siempre revestidas de paneles, unidas entre sí por una viga estructural de aluminio. Las mesas se pueden ampliar a cualquier dimensión y están disponibles en melamina y madera.*





Bravvo 2

## /inserto in pelle

Nei tavoli modulari realizzati in essenza è possibile applicare un inserto in cuoio con cuciture a contrasto. A discrezione del cliente è possibile applicare anche i top access sulla superficie rivestita.



***Leather insert** in wood modular tables it is possible to apply a leather insert with visible stitching. At the customer's discretion it is also possible to apply the top access on the upholstered surface.*

***Insert en cuir** dans les tables modulaires en bois: il est possible d'insérer une pièce ou un sous-main en cuir avec des coutures de couleur contrastantes ou pas. Selon la volonté du client, des top-access peuvent également être appliqués à la surface revêtue.*

***Inserto de cuero** en las mesas de reunión modulares en madera chapada, se puede aplicar un precioso inserto de cuero. A petición del cliente es posible aplicar los top access en la superficie tapizada.*



Bravvo 2



Bravvo 2



***Itidiness*** the structural beam used to connect legs and support table tops provides space for horizontal cable management. In fact, top accesses are placed directly on it and exploit the cavity.

***Iordre*** la poutre structurelle utilisée pour relier les jambes entre-elles et à la fois soutenir le dessus de la table, elle offre un espace pour le passage ordonné des câbles horizontalement. Les top access sont positionnés directement sur elle et profitent de son espace intérieur.

***Iorden*** la viga estructural que se utiliza para la unión de las patas permite el tránsito de los cables en sentido horizontal. El top access se coloca por encima en correspondencia de la viga aprovechando del espacio en su interior.

---

### **/ordine**

La trave strutturale utilizzata per collegare tra loro le gambe e supportare i piani del tavolo, offre lo spazio per il transito ordinato dei cavi in senso orizzontale. I top access infatti sono posizionati direttamente su di essa e ne sfruttano la cavità.





**/finiture piano** | top finishes | finitions plateau | acabados sobre



**Melaminico senza (A) e con profilo (B)\***  
 Italian melamine without (A) and with profile (B)\*  
 Mèlamine sans (A) et avec profil (B)\*  
 Melaminico sin (A) y con perfil (B)\*

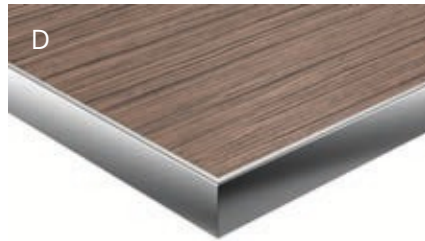

**Legno senza (C) e con profilo (D)\***  
 Wood veneer without (C) and with profile (D)\*  
 Bois sans profilé (C) et avec profilé (D)\*  
 Madera sin (C) y con perfil (D)\*

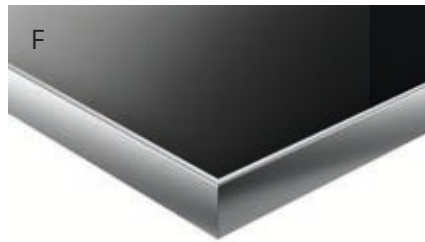
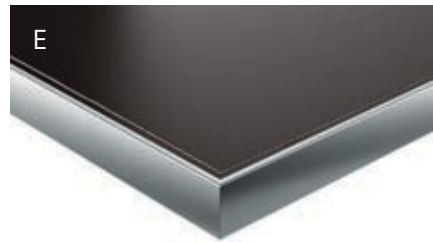

**Cuoio (E), vetro (F) e gres (G) con profilo\***  
 Leather (E), glass (F) and porcelain tiles (G) with profile\*  
 Cuir (E), verre (F) et grès (G) avec profil\*  
 Cuero (E), vidrio (F) y gres porcelánico (G) con perfil\*



**\*Il profilo metallico del piano può avere le seguenti finiture: anodizzato, brill, epossidico**

*\*The metal profile of the table top, can have the following finishes: anodised, brill, epoxy*  
*\*Le profil métallique du dessus peut avoir les finitions suivantes: anodisé, brillant, époxy*  
*\*El perfil metálico del sobre puede ser anodizado, brillante, pintado epoxy*

**/forme dei piani** | desk top shapes | formes de plateaux | formas de sobres

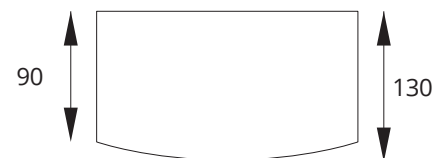

**/gambe** | legs | pieds | patas

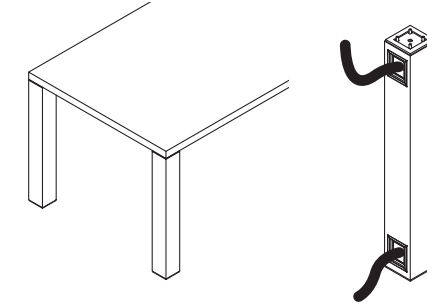
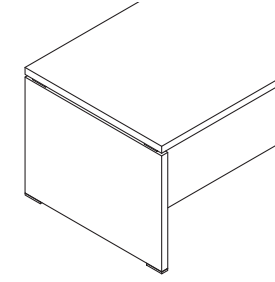

**gambe pannellate legno/melaminico**  
 panel legs - wood veneer/Italian melamine  
 piètements panneaux - bois/mélaminé  
 patas paneladas - madera/melaminico

**gambe angolari legno/melaminico**  
 corner legs - wood veneer/Italian melamine  
 piètements d'angle - bois/mélaminé  
 patas angulares - madera/melaminico

**/scrivania singola** | single desk | bureau individuel | mesa individual

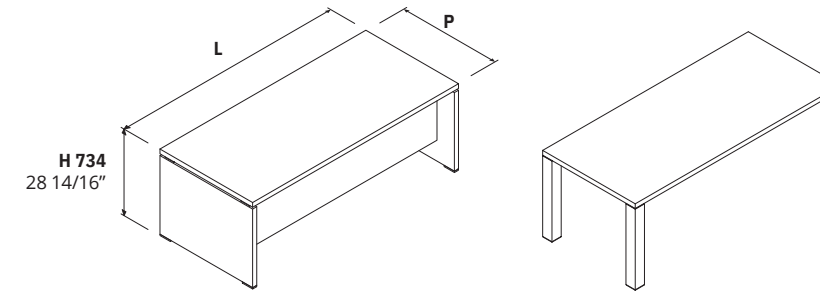

	<b>L 1800   70 14/16"</b>	<b>L 2000   78 12/16"</b>			
<b>P 900   35 7/16"</b>	•	•			

**/scrivania con muretto** | desk with extended leg | bureau avec pied panneau prolongée | mesa con costado lateral

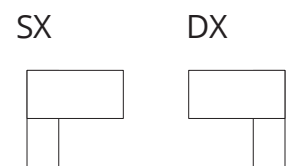
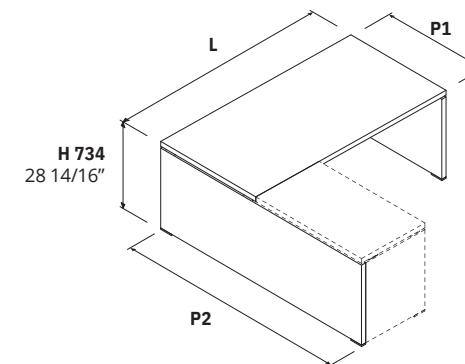

	<b>L 1800   70 14/16"</b>	<b>L 2000   78 12/16"</b>			
<b>P1 900   35 7/16"</b>	•	•			
<b>P2 1900   74 13/16"</b>					
<b>P1 900   35 7/16"</b>	•	•			
<b>P2 2100   82 11/16"</b>					

**/scrivania per mobile di servizio | desk for service unit | bureau pour meuble retour | mesa para mueble auxiliar**

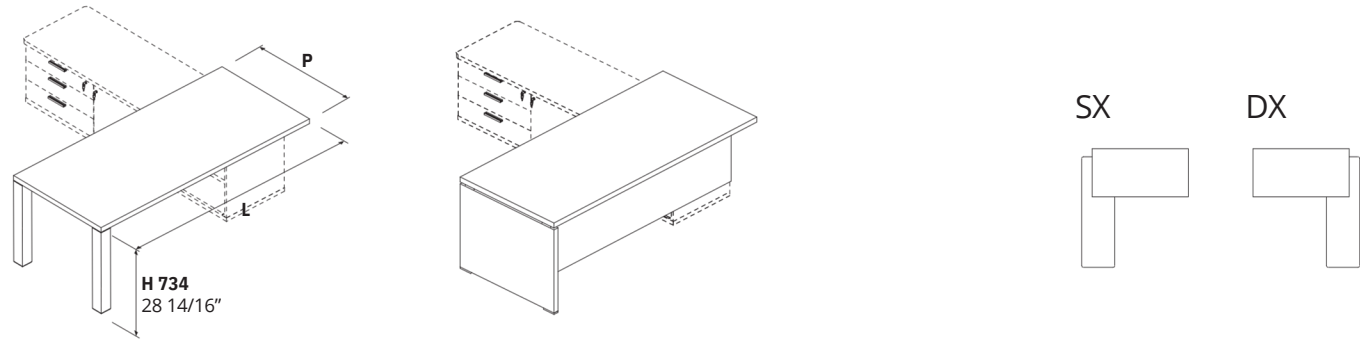

	<b>L 1800</b>   70 14/16"	<b>L 2000</b>   78 12/16"			
<b>P 900</b>   35 7/16"	•	•			

**/dattilo agganciati e indipendenti | hanging and freestanding returns | retours accrochés et indépendants | alas suspendidas y independientes**

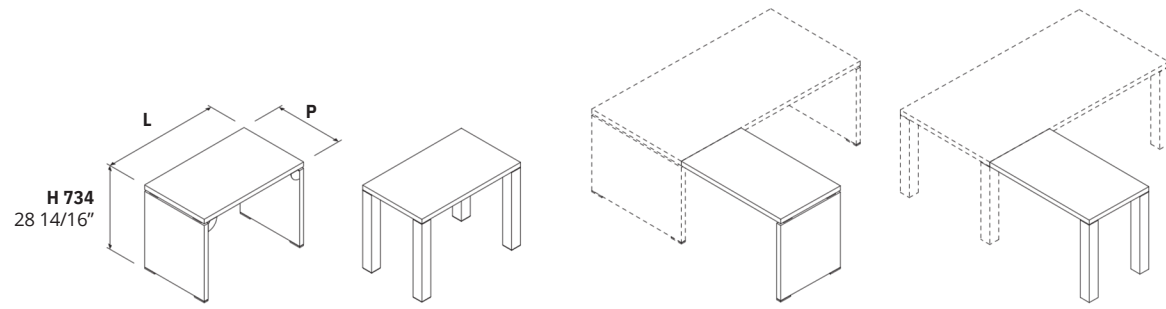

	<b>L 1000</b>   39 6/16"	<b>L 1200</b>   47 4/16"			
<b>P 600</b>   23 10/16"	•	•			

**/briefing | briefing | briefing | briefing**

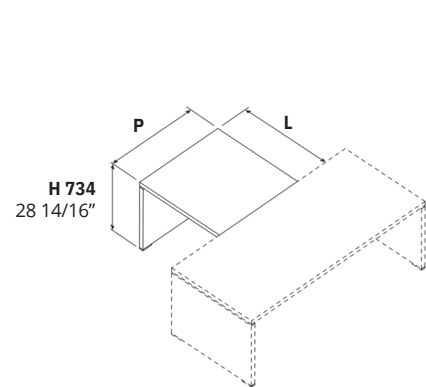

	<b>L 900</b>   35 7/16"	<b>L 1800</b>   70 14/16"			
<b>P 800</b>   31 8/16"	•				
<b>P 900</b>   35 7/16"		•			

Misure espresse in mm e pollici | Measures expressed in mm and inches | Mesures exprimées en mm et en pouces | Mediciones expresadas en mm y pulgadas

**/tavoli quadrati e rotondi con basamento metallico | square and round tables with metal base | tables carrées et rondes avec base en métal | mesas cuadradas y redondas con base de metal**

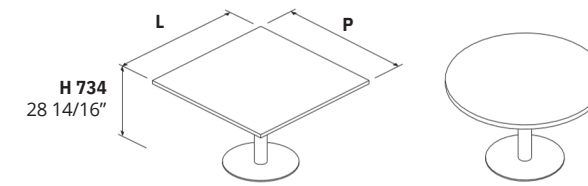

<b>L/P 800</b>   31 8/16"	<b>L/P 900</b>   35 7/16"	<b>L/P 1000</b>   39 6/16"	<b>L/P 1200</b>   47 4/16"		
•	•	•	•		

**/tavoli riunione quadrati | square meeting tables | tables de réunion carrées | mesas de juntas cuadradas**

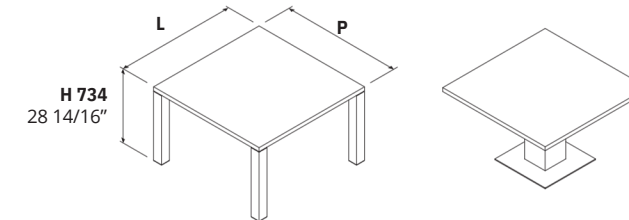

<b>L/P 800</b>   31 8/16"	<b>L/P 900</b>   35 7/16"	<b>L/P 1000</b>   39 6/16"	<b>L/P 1200</b>   47 4/16"	<b>L/P 1300</b>   51 3/16"	<b>L/P 1500</b>   59 1/16"
•	•	•	•	•	•

**/tavoli riunione | meeting tables | tables de réunion | mesas de juntas**

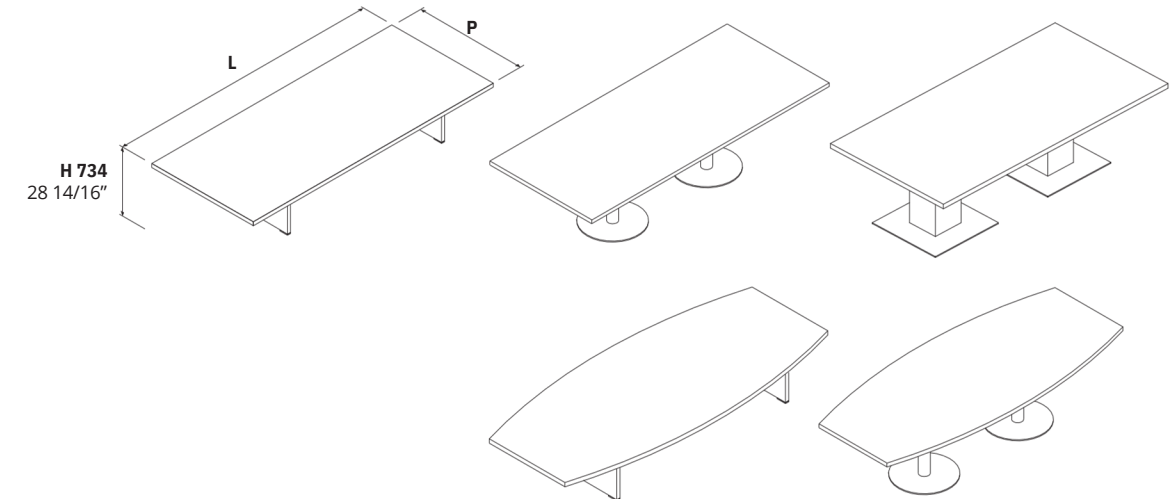

	<b>L 2100</b>   82 11/16"	<b>L 2800</b>   110 4/16"			
<b>P 1200</b>   47 4/16"	•	•			

Misure espresse in mm e pollici | Measures expressed in mm and inches | Mesures exprimées en mm et en pouces | Mediciones expresadas en mm y pulgadas

**/tavoli riunione** | meeting tables | tables de réunion | mesas de juntas

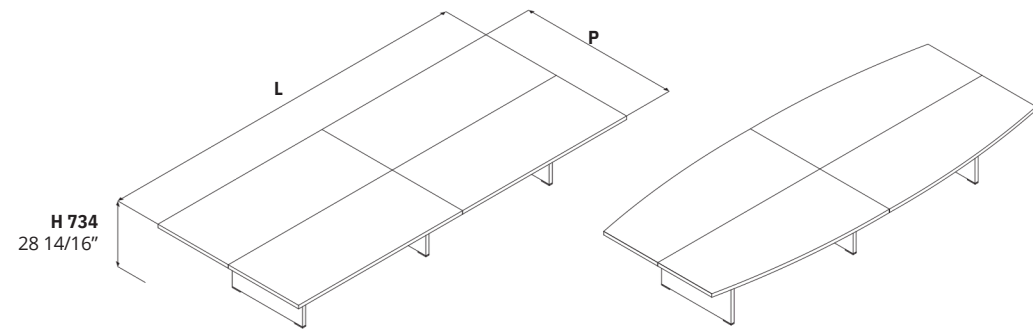

	<b>L 4200</b>   165 6/16"				
<b>P 1800</b>   70 14/16"	•				

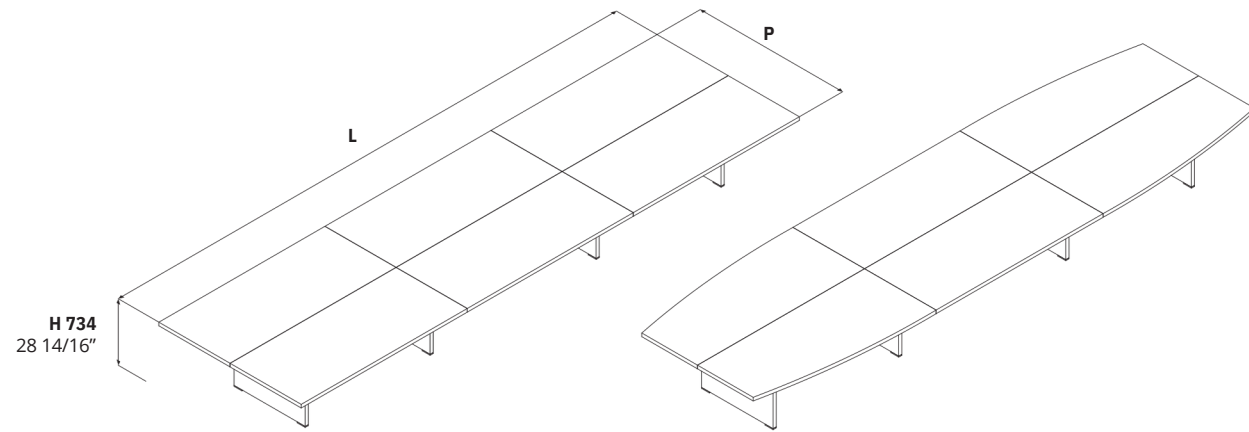

	<b>L 4900</b>   192 15/16"	<b>L 5600</b>   220 8/16"	<b>L 6300</b>   248"		
<b>P 1800</b>   70 14/16"	•	•	•		

**/tavolini da caffè** | coffee tables | tables basses | mesitas

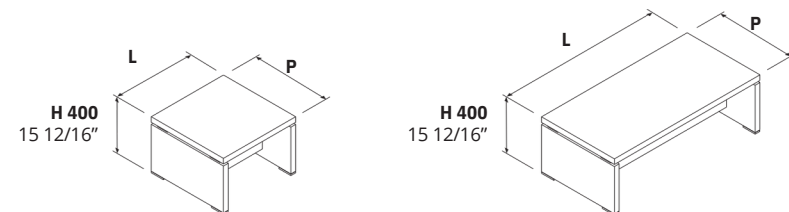

	<b>L 600</b>   35 7/16"	<b>L 1200</b>   47 4/16"			
<b>P 600</b>   31 8/16"	•	•			

**mobile di servizio fisso** | freestanding service unit | meuble retour fixe sur patins | mueble auxiliar con pies

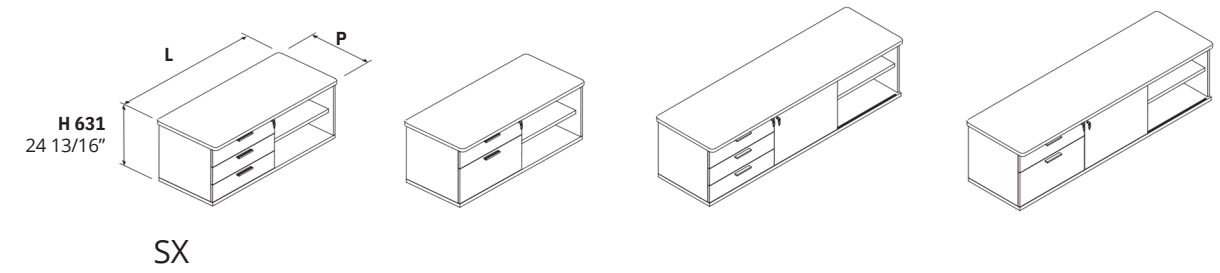

	<b>L 1385</b>   54 8/16"	<b>L 1800</b>   70 14/16"	<b>L 2067</b>   81 6/16"		
<b>P 598</b>   23 9/16"	•	•	•		

**Mobili di servizio su ruote** | mobile service unit with casters | meuble retour mobile sur roulettes | armarios con ruedas

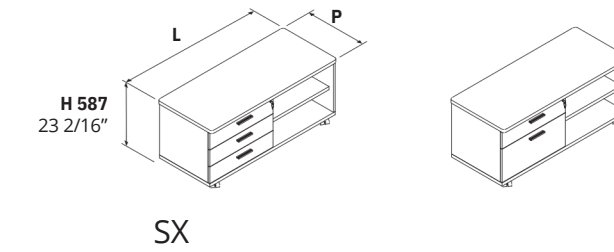

	<b>L 1385</b>   54 8/16"				
<b>P 598</b>   23 9/16"	•				





# Finiture | Finishes | Finitions | Acabados

## MEL

### Melaminico

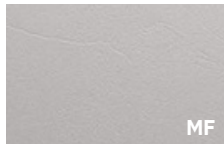
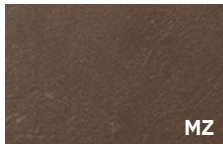
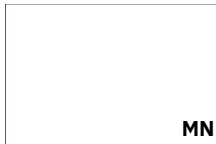
Melamine | Mélaminé | Melaminico

TOP MOB MOD

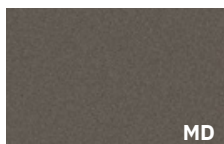
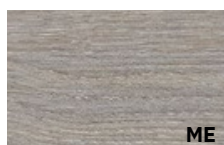
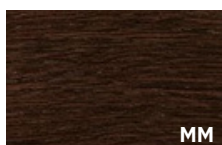
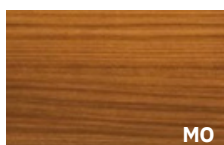

 <b>Bianco rigato</b> Rippled effect white Blanc avec rayures en sérigraphie Bianco rayado	 <b>Grigio rigato</b> Rippled effect grey Gris avec rayures en sérigraphie Gris rayado	 <b>Nichel</b> Nickel Nickel	 <b>Cacao</b> Cocoa Cacao Cacao	 <b>Bianco</b> White Blanc Blanco
 <b>Talco</b> Talco Talco Talco	 <b>Ocra</b> Ochre Ocre Ocre	 <b>Safari</b> Safari Safari Safari	 <b>Noisette</b> Noisette Noisette Noisette	 <b>Verde</b> Green Vert Verde
 <b>Nero</b> Black Noir Negro	 <b>Blu notte</b> Night blue Bleu nuit Azul noche	 <b>Ardesia</b> Ardesia Ardesia Pizarra	 <b>Rovere chiaro</b> Light oak Chêne clair Roble claro	 <b>Rovere americano</b> American oak Chêne américain Roble americano
 <b>Rovere grigio</b> Grey oak Chêne gris Roble gris	 <b>Rovere moro</b> Dark oak Chêne foncé Roble oscuro	 <b>Noce Canaletto</b> Canaletto Walnut Noyer Canaletto Nogal Canaletto	 <b>Noce scuro</b> Dark walnut Noyer foncé Nogal oscuro	

## LGN

### Legno

Wood | Bois | Madera

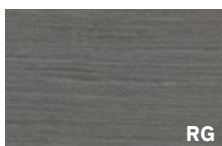
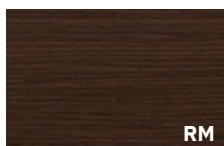
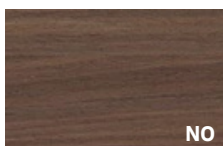
TOP MOB MOD

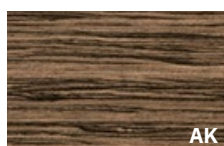
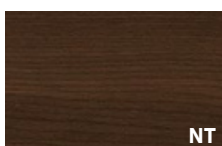







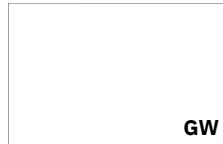
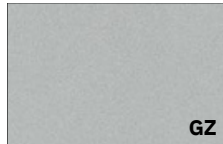

 <b>Rovere chiaro</b> Light oak Chêne clair Roble claro	 <b>Rovere grigio fumo</b> Smoke grey oak Chêne gris de fumée Roble gris humo	 <b>Rovere moro</b> Dark oak Chêne foncé Roble oscuro	 <b>Noce Canaletto</b> Canaletto walnut Noyer Canaletto Nogal Canaletto	 <b>Ebano silver</b> Silver ebony Ebony silver Ebano plata
 <b>Ebano Makassar</b> Makassar ebony Ebony Makassar Ebano Makassar	 <b>Noce termocotto</b> Heat-treated walnut Noyer thermo traité Nogal termotratado			

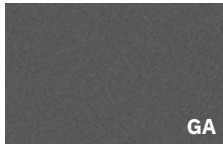
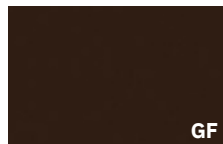
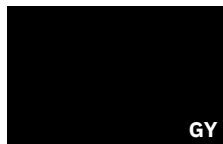
## VTR

### Vetro (anche antimpronta NFG)

Glass (also antifinger NFG) | Verre (également antitaches) | Vidrio (también anti-huella)

TOP



 <b>Bianco</b> White Blanc Blanco	 <b>Argento</b> Silver Argent Plata	 <b>Grigio scuro</b> Dark grey Gris foncé Gris oscuro	 <b>Noisette</b> Noisette Noisette Noisette	 <b>Ardesia</b> Ardesia Ardesia Pizarra
 <b>Moka</b> Mocha Moka Cafe	 <b>Nero</b> Black Noir Negro	 <b>Arancione</b> Orange Orange Naranja	 <b>Rosso "F"</b> Red "F" Rouge "F" Rojo "F"	 <b>Rubino</b> Ruby Rubis Rubi
 <b>Indaco</b> Indigo Indigo Azul Indigo	 <b>Azzurro</b> Blue Bleu Azul	 <b>Verde</b> Green Vert Verde	 <b>Cedro</b> Lime green Vert Cédrot Verde Cedro	

## GRES

### Gres porcellanato

Porcelain tiles | Grès cérame | Gres porcelánico

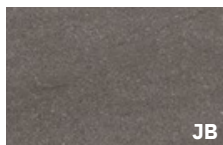
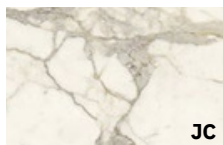
TOP

 <b>Nero</b> Black Noir Negro	 <b>Basalt</b> Basalt Basalt Basalt	 <b>Calacatta</b> Calacatta Calacatta Calacatta	 <b>Pulpis</b> Pulpis Pulpis Pulpis	 <b>Corten</b> Corten Corten Corten
--	--	--	--	--

## CUO

### Cuoio

Leather | Cuir | Cuero

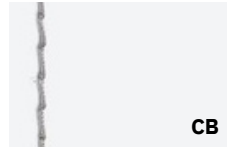

**Bianco**  
White  
Blanc  
Blanco



**Alluminio**  
Aluminium  
Aluminium  
Aluminio



**Nero**  
Black  
Noir  
Negro



**Testa di moro**  
Brown  
Tete de maure  
Marron oscuro



**Caramello**  
Caramel  
Caramel  
Caramelo



**Arancione**  
Orange  
Orange  
Naranja

TOP

## EPX

### Epossidico

Epoxy | Époxy | Epoxi



**Bianco**  
White  
Blanc  
Blanco

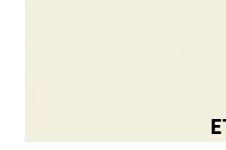

**Talco**  
Talco  
Talco  
Talco

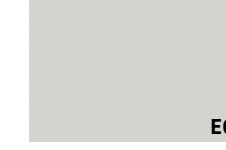

**Grigio**  
Grey  
Gris  
Gris



**Beige Arizona**  
Arizona beige  
Beige Arizona  
Beige Arizona



**Noisette**  
Noisette  
Noisette  
Noisette

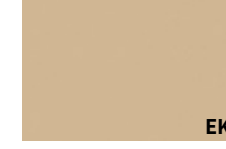

**Safari**  
Safari  
Safari  
Safari

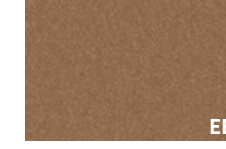

**Rame**  
Copper  
Cuivre  
Cobre



**Rosso Jaipur**  
Jaipur red  
Rouge Jaipur  
Rojo Jaipur

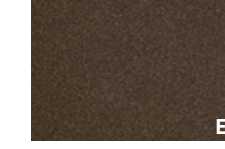

**Bronzo**  
Bronze  
Bronze  
Bronce



**Blu notte**  
Night blue  
Bleu nuit  
Azul noche



**Grigio Bromo**  
Bromo grey  
Gris Bromo  
Gris Bromo

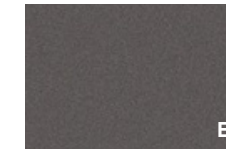

**Ardesia**  
Ardesia  
Ardesia  
Pizarra



**Verde Comodoro**  
Comodoro green  
Vert Comodoro  
Verde Comodoro

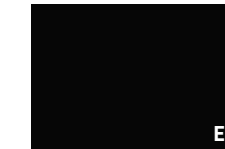

**Nero**  
Black  
Noir  
Negro

PR

STRU

## BR

### Alluminio

Aluminium | Aluminium | Aluminio



**Brill**  
Brill  
Brill  
Brill  
Brill

PR

## Applicazioni finiture

Finish application | Application finitions | Aplicacion acabados



**Piano**  
Top  
Plateau  
Sobre



**Modesty panel**  
Modesty panel  
Voile de fond  
Faldón



**Mobile di servizio**  
Service unit  
Meuble de service  
Mueble de servicio



**Struttura**  
Structure  
Structure  
Structura



**Profilo scrivania**  
Top edge  
Chant plateau  
Perfil sobre de mesa

**ecologia**

Auraa utilizza per i suoi prodotti e i suoi imballi materiali facilmente separabili e riciclabili.

**attestazione di prodotto**

I prodotti Auraa sono stati sottoposti a prove prestazionali presso laboratori di prova accreditati. Copia dei rapporti di prova o delle attestazioni di conformità sono disponibili su richiesta. I prodotti Auraa soddisfano i requisiti LEED per il credito IEQ4.5 per i materiali a bassa emissione ed i requisiti ANSI/BIFMA X7.1-2011. Auraa dichiara di utilizzare pannelli a base di legno aventi un rilascio di formaldeide conforme alla classe E1 secondo il DM 10/10/2008. Auraa si impegna inoltre ad utilizzare materiali legnosi FSC e pannelli a base di legno con certificazione CARB2.

**environment**

*Auraa products and packaging are made of recyclable materials.*

**product certification**

*Auraa products have been subjected to performance tests at accredited testing laboratories. Copies of test reports or certificates of conformity are available on request. Auraa products meet the LEED requirements for IEQ4.5 credit for low emission materials and the ANSI/BIFMA X7.1-2011 requirements. Auraa declares to use wood-based panels with a formaldehyde release according to class E1 according to DM 10/10/2008. Auraa also undertakes to use FSC wood-based materials and CARB2-certified wood-based panels.*

**environnement**

*Auraa utilise des matériaux facilement divisibles et recyclables pour ses produits et ses emballages.*

**certification de produits**

*Les produits Auraa ont été soumis à des tests de performance dans des laboratoires accrédités. Des copies des rapports d'essais ou des certificats de conformité sont disponibles sur demande. Les produits Auraa répondent aux exigences LEED pour le crédit IEQ4.5 pour les matériaux à faibles émissions et aux exigences ANSI/BIFMA X7.1-2011. Auraa déclare utiliser des panneaux à base de bois avec un dégagement de formaldéhyde selon la classe E1 selon DM 10/10/2008. Auraa s'engage également à utiliser des matériaux à base de bois FSC et des panneaux à base de bois certifiés CARB2.*

**ecología**

*Auraa utiliza productos y embalajes en materiales fácilmente separables y reciclables.*

**certificación de producto**

*Los productos Auraa han sido sometidos a pruebas de rendimiento en laboratorios de pruebas acreditados. Copias de los informes de las pruebas o certificados de conformidad están disponibles bajo petición. Los productos Auraa cumplen con los requisitos LEED para el crédito IEQ4.5 para materiales de baja emisión y los requisitos ANSI/BIFMA X7.1-2011. Auraa declara utilizar paneles de madera con una emisión de formaldehído según la clase E1 según DM 10/10/2008. Auraa también se compromete a utilizar materiales a base de madera FSC y paneles a base de madera certificados por CARB2.*

**concept & graphic design**

Auraa marketing + communication

**design**

Filippon & Mirto Antonel

**art direction**

Mirto Antonel

AF/CACB/AB

# aura design



Hub Spaces, 582 Honeypot Lane, Stanmore, HA7 1JS, UK  
[www.auraadesign.co.uk](http://www.auraadesign.co.uk)  
020 3915 8008  
[info@auraadesign.co.uk](mailto:info@auraadesign.co.uk)

