

Blanca



operativi | workstations | systemes | operativos

Lo spazio ibrido diventa realtà

Blanca nasce come
collezione adattabile
alle diverse funzioni
dell'ambiente
di lavoro
contemporaneo.

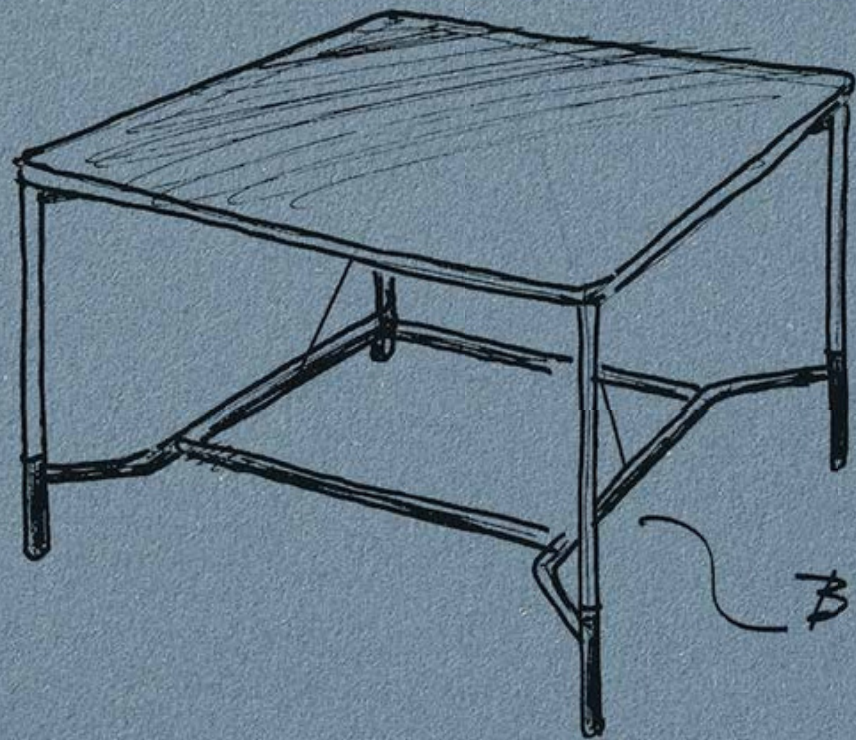

BICOLOR

Blanca was created as a
collection adaptable to the
multiple functions of the
contemporary workplace.

Blanca a été créé comme une
collection adaptable aux
différentes fonctions de
l'environnement de travail
contemporain.

Blanca nace como una
colección adaptable
a las diferentes
funciones del entorno
de trabajo
contemporáneo.

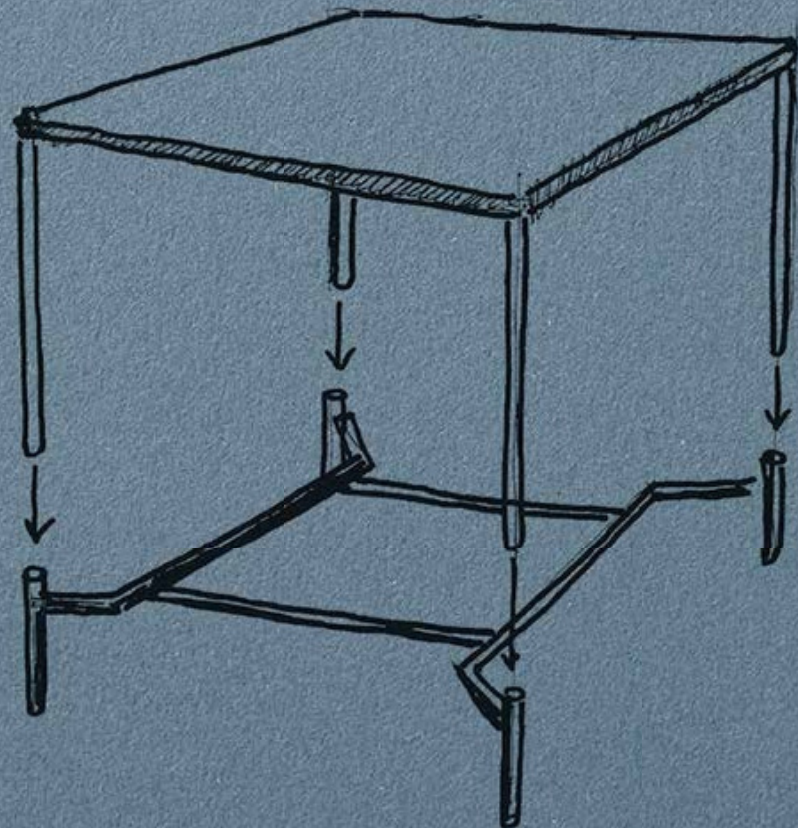

Blanca

Condivisione

Blanca è stato progettato per agevolare la condivisione dello spazio. In un'epoca dove la flessibilità in termini di modi e luoghi diventa un must, questa collezione si apre a molteplici interpretazioni.



Tavolo | Table | Table | Mesa **Fin.** MD, EI, EE
L/P 160 H 105 cm | W/D 63" H 41 3/8"

Blanca

Sharing Blanca is designed to create collaboration spaces. In an age where flexibility in terms of ways and places is becoming a must, this collection is open to multiple interpretations.

Partager Blanca est conçu pour créer des espaces de collaboration. À une époque où la flexibilité en termes de moyens et de lieux devient un must, cette collection est ouverte à de multiples interprétations.

Compartir Blanca ha sido diseñado para facilitar el uso compartido del espacio. En una época en la que la flexibilidad en términos de modos y lugares se hace imprescindible, esta colección se abre a múltiples interpretaciones.

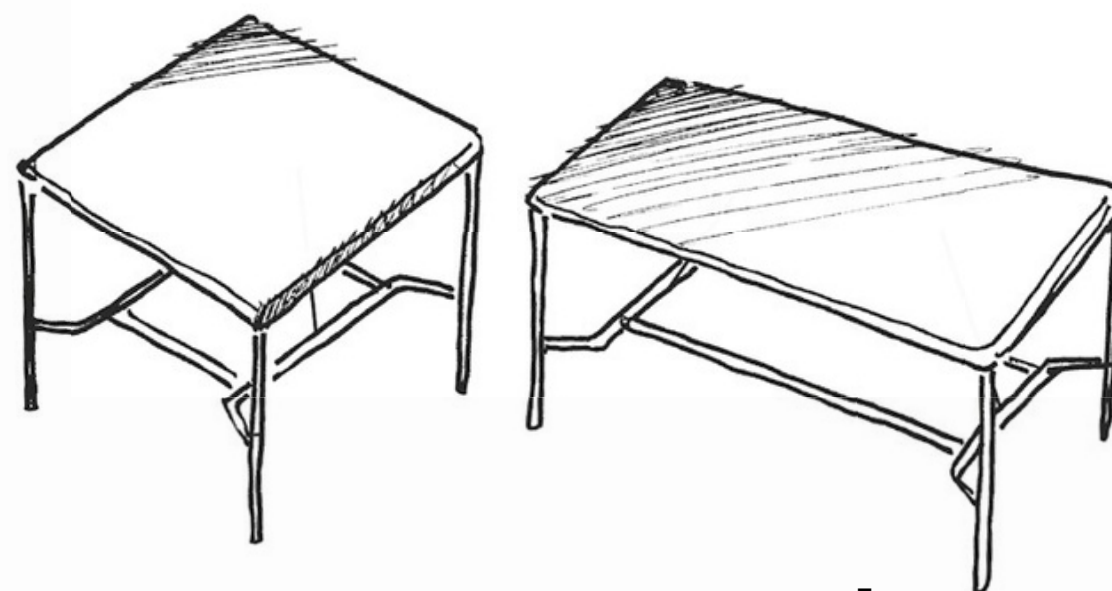

Blanca



Bench | Bench | Bench | Bench Fin. MD, EI
L 300 P 100 H 73,4 cm | W 118 1/8" D 39 3/8" H 28 7/8"



Leggerezza

La struttura è composta da gambe tubolari in metallo verniciato dal diametro di 35 mm, che supportano piani di spessore 18 mm. Gli angoli possono essere sia dritti che raggiati. Nel secondo caso la curva creata va ad armonizzare il punto dove piano e gamba si incontrano.



Bench | Bench | Bench | Bench Fin. MI, EO, DC
L 400 P 160 H 73,4 cm | W 157 1/2" D 63" H 28 7/8"

Blanca 1

Lightweight The structure is composed of tubular legs in painted metal with a diameter of 35 mm (1 3/8"), which support 18 mm (11/16") thick tops. The corners can be either straight or round. In the second case, the curve creates the point where top and leg meet.

Lègèreté La structure est composée de pieds tubulaires de 35 mm de diamètre en métal peint, qui soutiennent des plateaux de 18 mm d'épaisseur caractérisés par un rayon sur les quatres angles, qui harmonise le point de jonction des deux éléments.



Tavolo | Table | Mesa Fin. MI, EO, EI
L 300 P 100 H 105 cm | W 118 1/8" D 39 3/8" H 41 3/8"

Ligereza La estructura se compone de patas tubulares de 35 mm de diámetro en metal pintado, que soportan tableros de 18 mm de grosor. Las esquinas pueden ser rectas o redondeadas. En este último caso la curva que se crea armoniza el punto de encuentro entre sobre y pata.



I piani sono ampi e la palette di finiture disponibili comprende tutti i colori dei melaminici, degli impiallacciati e dei Fenix standard Auraa Design.



Blanca 1

Tops are wide and the palette of available finishes includes all colours of Auraa Design standard melamine, veneer and Fenix.

Les plateaux sont larges et la palette des finitions disponibles comprend toutes les couleurs de la mélamine, du placage et du Fenix standard Auraa Design.

Las encimeras son amplias y la paleta de acabados disponibles incluye todos los colores de melamina, chapa de madera y Fenix estándar de Auraa Design.

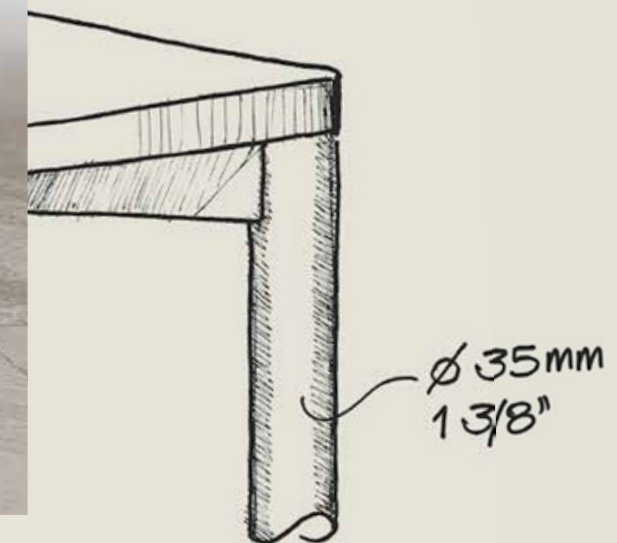

Blanca

Eleganza informale

Blanca si adatta molto bene ad arredare uffici privati e manageriali. L'impiallacciatura del top impreziosisce tutto il suo design, del quale persiste l'eleganza informale.

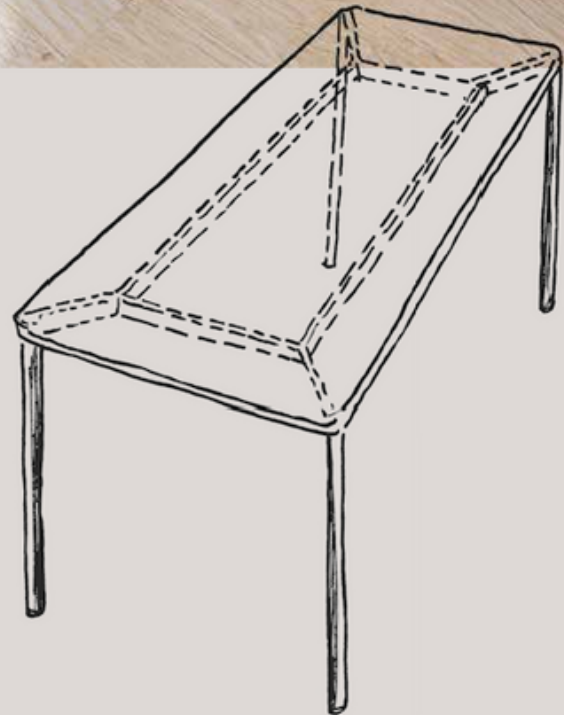

Informal elegance Blanca is well suited to private and managerial offices. The veneered top enhances the whole design, whose informal elegance persists.

Élégance informelle Blanca est bien adapté aux bureaux privés et aux bureaux de direction. Le plateau en bois plaqué embellit l'ensemble de son design, dont l'élégance informelle persiste.

Blanca

Elegancia informal Blanca se adapta bien a las oficinas privadas y de dirección. La encimera chapada embellece todo su diseño, cuya elegancia informal persiste.



Blanca

Scrivania | Desk | Bureau | Mesa Fin. ML, EN
L 220 P 100 H 73,4 cm | W 94 1/2" D 47 1/4" H 28 7/8"





Scrivania | Desk | Bureau | Mesa Fin. MK, EZ
 L 200 P 80 H 73,4 cm | W 78 3/4" D 31 1/2" H 28 7/8"
 Tavolo | Table | Mesa Fin. MK, EZ
 L 200 P 120 H 105 cm | W 78 3/4" D 47 1/4" H 41 3/8"

Blanca

Les tables Blanca peuvent couvrir une longueur de 300 cm maxi aux meubles de service équipés de tiroirs et compartiments ouverts avec top arrondis.

Las mesas Blanca pueden cubrir longitudes de hasta 300 cm y se adaptan bien a los contenedores de servicio con tableros redondeados que vienen con cajones y compartimentos abiertos.



I tavoli Blanca arrivano a coprire campate di 300 cm e ben si abbinano ai contenitori di servizio con top dagli angoli arrotondati che si propongono con cassettera e vano a giorno.

Blanca tables can cover spans of up to 300 cm (118 1/8") and are well matched to the service units with rounded-corner tops, which are offered with drawers and open compartment.

Blanca

Home office

La semplicità di Blanca lo rende un elemento facile da inserire all'interno di un contesto domestico. I volumi e il comfort dell'ufficio si trasferiscono a casa.





Blanca simplicity makes it an easy element to integrate into a domestic context. Office volumes and comfort are transferred at home.

Scrivania | Desk | Bureau | Mesa Fin. NT, EZ
L 200 P 100 H 73,4 cm | W 78 3/4" D 39 3/8" H 28 7/8"

Blanca

La simplicité de Blanca en fait le rendre un élément facile à intégrer dans un contexte domestique. Les volumes et le confort du bureau sont transférés à la maison.

La sencillez de Blanca hace que sea un elemento fácil de integrar en un contexto doméstico. Los volúmenes y el confort de la oficina se trasladan al hogar.





Tavolo | Table | Mesa Fin. MD, EI, YB
 L 160 P 80 H 73,4 cm | W 63" D 31 1/2" H 28 7/8"
 Tavolo | Table | Mesa Fin. MD, EI, YB
 L 220 P 80 H 105 cm | W 86 5/8" D 31 1/2" H 41 3/8"

Blanca

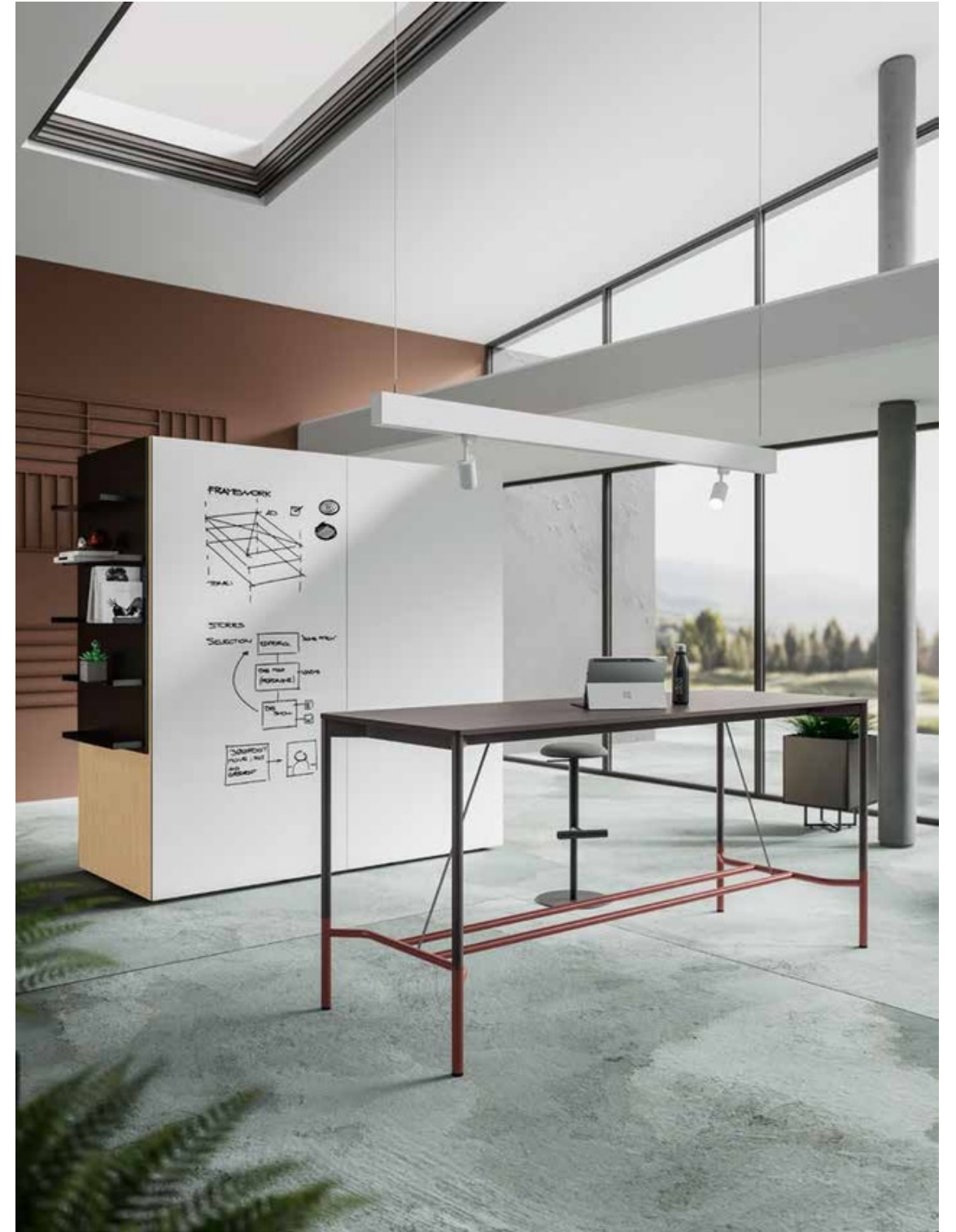

Blanca



Tavolo | Table | Table | Mesa Fin. MT, ET, EO
Ø 150 H 90 cm | Ø 59" H 35 3/8"
Tavolo | Table | Table | Mesa Fin. MT, ET, EO
Ø 120 H 105 cm | Ø 47 1/4" H 41 3/8"



Blanca

Height Tables start at a height of 73,4 cm (28 7/8"), which can be increased to 90 (35 3/8") or 105 cm (41 3/8") thanks to an additional base frame with footrest, which can be painted in a different colour and can be added or removed as required.

Altezze

I tavoli partono da un'altezza di 73,4 cm, che si può aumentare arrivando a 90 o 105 cm. Questo incremento avviene grazie ad una struttura di base addizionale, provvista di poggiapiedi, che si può colorare diversamente rispetto alle gambe e può essere aggiunta o rimossa a piacere.

Hauteur La première hauteur de la table est de 73,4cm, qu'on peut augmenter jusqu'à 90cm ou 105 cm. Ces dernières dimensions peuvent être atteints grâce à une structure additionnelle équipée de repose-pieds, qui peut avoir une finition différente par rapport au pieds fixes. Elle pourra être ajoutée et enlevée à discrétion.

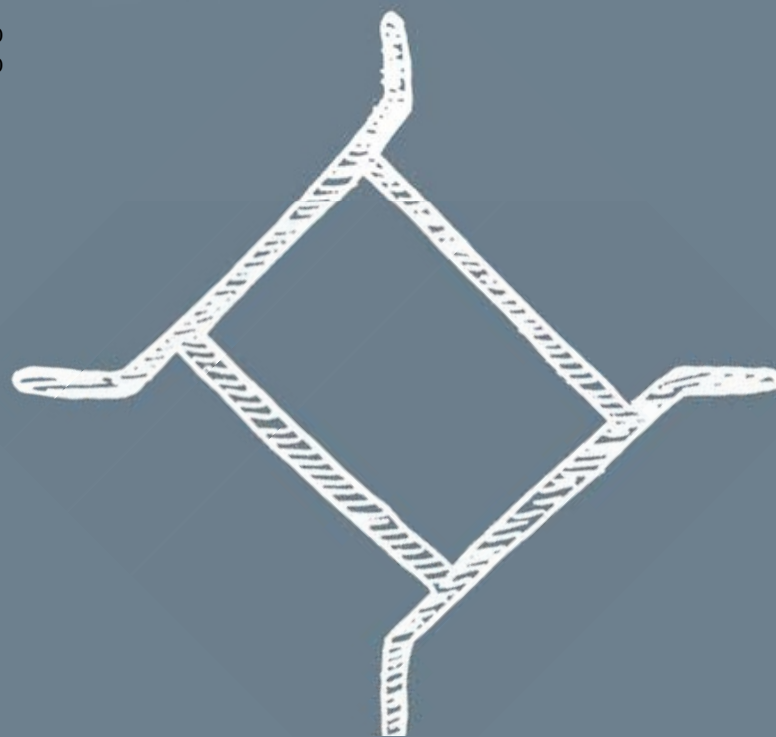

Altura Las mesas parten de una altura de 73,4 cm, que se puede aumentar alcanzando los 90 o 105 cm. Este aumento se produce gracias a una estructura básica adicional, equipada con reposapiés, que se puede colorar de un color diferente de las patas y se puede añadir o eliminar a voluntad.

Blanca

Opzioni

Per i tavoli H 73,4 e H 105 cm fino a lunghezza 200 cm, è disponibile la versione su ruote. Queste vengono innestate in una struttura apposita così da mantenere invariata l'altezza del piano.

Options For tables H 73,4 (28 7/8") and H 105 cm (41 3/8") up to a length of 200 cm (78 3/4"), a version with castors is available. These are inserted into a special structure so that the height of the table top does not change.

Options Pour les tables H 73,4 et H 105 cm jusqu'à une longueur de 200 cm, une version avec roulettes est disponible. Celles-ci sont insérées dans une structure spéciale de sorte que la hauteur du plateau de la table ne change pas.

Opciones Para mesas H 73,4 y H 105 cm hasta una longitud de 200 cm, hay disponible una versión con ruedas. Éstas se insertan en una estructura especial para que la altura del tablero de la mesa no varíe.

Tavolo | Table | Table | Mesa
L/P 150 H 105 cm | W/D 59" H 41 3/8"
Fin. MW, EZ, EN





Blanca

Forme

I piani dei tavoli Blanca possono avere forme particolari come quella a 8 (che permette l'accostamento di due diversi colori) oppure quella ovoidale.

Shapes The tops of Blanca tables can have special shapes such as the 8-shape (which allows the combination of two different colours) or the ovoid shape.

Formes Les plateaux des tables Blanca peuvent avoir des formes particulières comme la forme en 8 (qui permet de combiner deux couleurs différentes) ou la forme ovoïde.

Formas Los tableros de las mesas Blanca pueden tener formas especiales, como la forma de 8 (que permite combinar dos colores distintos) o la forma ovalada.



Tavolo | Table | Mesa | Fin. MT, MJ, ET, EI
L 240 P 140 H 105 cm | W 94 1/2" D 55 1/8" H 41 3/8"

Blanca



Tavolo | Table | Mesa **Fin.** ML, EN
L 240 P 140 H 73,4 cm | W 94 1/2" D 55 1/8" H 28 7/8"

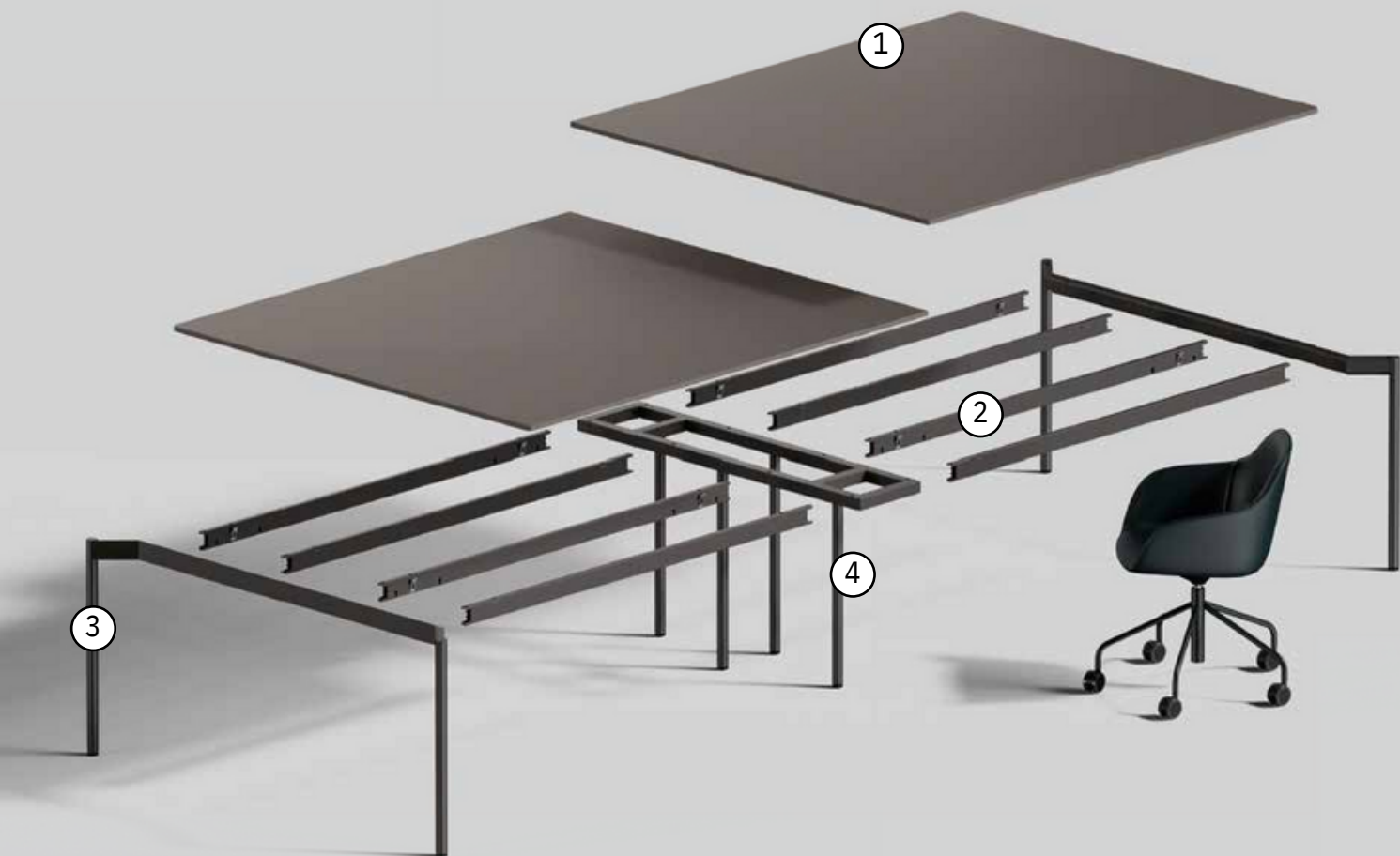

1. Piani per bench fino a 200x160 cm | 2. Longheroni | 3. Gambe terminali | 4. Gamba intermedia per tavoli multipli/bench

1. Bench tops up to 200x160 cm (78 3/4"x 63") | 2. Structural beams | 3. End legs | 4. Intermediate legs for multiple tables/benches

1. Plateaux pour tables jusqu'à 200x160 cm | 2. Poutres | 3. Pieds terminaux | 4. Pied intermédiaire pour tables multiples/bench

1. Sobres para bench hasta 200x160 cm | 2. Travesaños | 3. Patas terminales | 4. Pata intermedia para mesas múltiples/bench



Piani | Desk tops | Plateaux | Sobres
 Spessore 1,8 cm | 1,8 cm (3/4") thick | 1,8 cm d'épaisseur | 1,8 cm de espesor

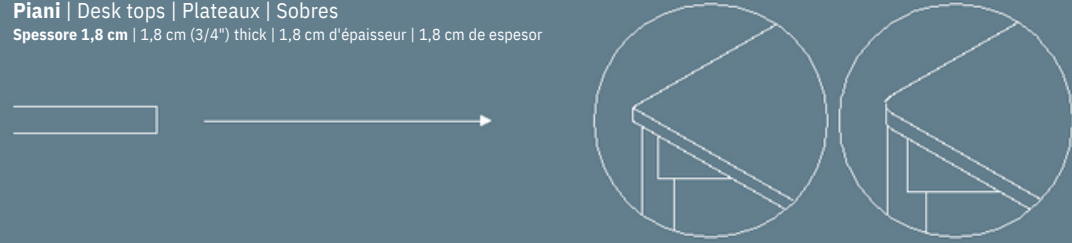

Struttura | Structure | Structure | Estructura
 Sezione Ø 3,5 cm | Section Ø 3,5 cm (1 3/8") | Section Ø 3,5 cm | Sección Ø 3,5 cm

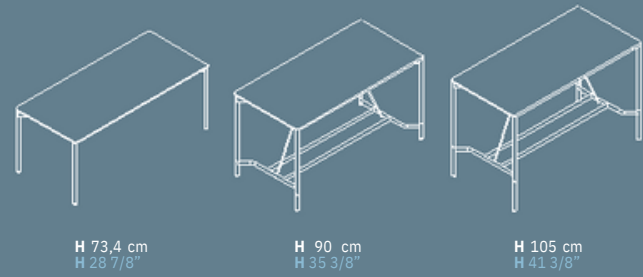

H 73,4 cm
H 28 7/8"

H 90 cm
H 35 3/8"

H 105 cm
H 41 3/8"



Ruote disponibili per H 73,4 e H 105 cm fino a L 200 cm
 Castors available for H 73,4 (28 7/8") and H 105 cm (41 3/8") up to W 200 cm (78 3/4")
 Roulettes disponibles pour H 73,4 et H 105 cm jusqu'à L 200 cm
 Ruedas disponibles para H 73,4 y H 105 cm hasta L 200 cm

Scrivanie/tavoli | Desks/tables | Bureaux/tables | Mesas



H 73,4
H 28 7/8"

L 120/140/160 - P 80 cm
W 47 1/4"-55 1/8"-63" - D 31 1/2"

H 73,4/90/105 cm
H 28 7/8"-35 3/8"-41 3/8"

L 180/200/220/260/300 - P 80/100 cm
W 70 7/8"-78 3/4"-86 5/8"-102 3/8"-118 1/8" -D 31 1/2"-39 3/8"

Bench | Bench | Bench | Bench

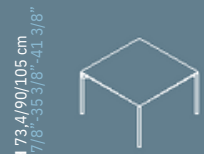

H 73,4/90/105 cm
H 28 7/8"-35 3/8"-41 3/8"

L 120/140/150/160/180/200 - P 120/150/160 cm
W 47 1/4"-55 1/8"-59"-63"-70 7/8"-78 3/4" -D 47 1/4"-59"-63"

Bench/tavoli multipli | Bench/multiple tables | Bench/tables multiples | Bench/múltiples mesas



H 73,4/90/105 cm
H 28 7/8"-35 3/8"-41 3/8"

L 240/280/320/360/400 - P 80/100/120/150/160 cm
W 94 1/2"-110 1/4"-126"-141 3/4"-157 1/2" -D 31 1/2"-39 3/8"-47 1/4"-59"-63"

L 360/420/480/540/600 - P 80/100/120/150/160 cm
W 141 3/4"-165 3/8"-189"-212 5/8"-236 1/4" -D 31 1/2"-39 3/8"-47 1/4"-59"-63"

Tavoli riunione | Meeting tables | Tables de réunion | Mesas de juntas



H 73,4/90/105 cm
H 28 7/8"-35 3/8"-41 3/8"

Ø 120/150 cm
Ø 47 1/4"-59"

L 210/240 - P 120/140 cm
W 82 5/8"-94 1/2" -D 47 1/4"-55 1/8"

Finiture | Finishes | Finitions | Acabados

TOP

MEL

Melaminico

Melamine | Mélaminé | Melaminico



Bianco rigato
Rippled effect white
Blanc avec rayures en sérigraphie
Blanco rayado



Grigio rigato
Rippled effect grey
Gris avec rayures en sérigraphie
Gris rayado



Nichel
Nickel
Nickel
Niquel



Cacao
Cocoa
Cacao
Cacao

MN

Bianco
White
Blanc
Blanco

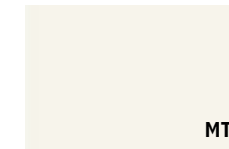

Talco
Talco
Talco
Talco



Ocra
Ochre
Ocre
Ocre



Safari
Safari
Safari
Safari



Noisette
Noisette
Noisette
Noisette



Verde
Green
Vert
Verde

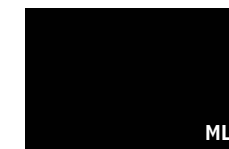

Nero
Black
Noir
Negro



Blu notte
Night blue
Bleu nuit
Azul noche



Ardesia
Ardesia
Ardesia
Pizarra



Rovere chiaro
Light oak
Chêne clair
Roble claro

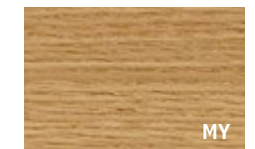

Rovere americano
American oak
Chêne américain
Roble americano



Rovere grigio
Grey oak
Chêne gris
Roble gris



Rovere moro
Dark oak
Chêne foncé
Roble oscuro



Noce Canaletto
Canaletto Walnut
Noyer Canaletto
Nogal Canaletto



Noce scuro
Dark walnut
Noyer foncé
Nogal oscuro

LGN

Legno

Wood | Bois | Madera



Rovere chiaro
Light oak
Chêne clair
Roble claro

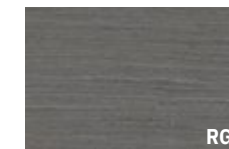

Rovere grigio fumo
Smoke grey oak
Chêne gris de fumée
Roble gris humo

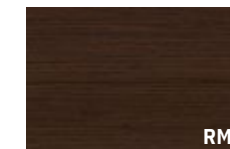

Rovere moro
Dark oak
Chêne foncé
Roble oscuro

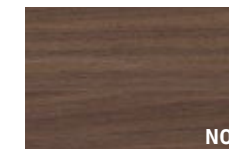

Noce Canaletto
Canaletto Walnut
Noyer Canaletto
Nogal Canaletto



Ebano Silver
Silver ebony
Ebony Silver
Ebano plata

TOP

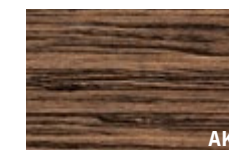

Ebano Makassar
Makassar ebony
Ebony Makassar
Ebano Makassar



Noce termocotto
Heat-treated walnut
Noyer thermo traité
Nogal termotratado

FNX

Fenix

Fenix | Fenix | Fenix

TOP



Bianco
White
Blanc
Blanco



Beige Arizona
Arizona beige
Beige Arizona
Beige Arizona



Blu Fes
Fes blue
Bleu Fes
Azul Fes



Grigio Bromo
Bromo grey
Gris Bromo
Gris Bromo



Verde Comodoro
Comodoro green
Vert Comodoro
Verde Comodoro



Nero
Black
Noir
Negro



Rosso Jaipur
Jaipur red
Rouge Jaipur
Rojo Jaipur

TES

Tessuto

Fabric | Tissu | Tejido

SCR



Beige
Beige
Beige
Beige



Grigio chiaro
Light grey
Gris clair
Gris claro



Ardesia
Ardesia
Ardesia
Pizarra



Blu avio
Avio blue
Bleu avio
Azul avio



Acquamarina
Aquamarine
Aigue-marine
Aguamarina

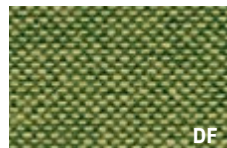

Verde primavera
Spring green
Vert printemps
Verde primavera

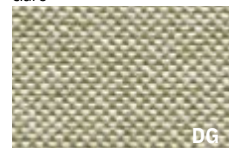

Salvia
Sage
Sauge
Salvia



Arancio
Orange
Orange
Naranja



Corallo
Coral
Corail
Coral

EPX

Epossidico

Epoxy | Époxy | Epoxi

STRU

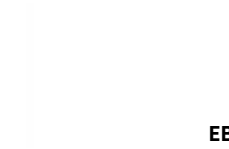

Bianco
White
Blanc
Blanco

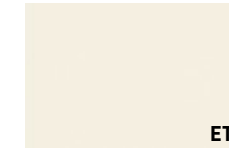

Talco
Talco
Talco
Talco



Grigio
Grey
Gris
Gris



Beige Arizona
Arizona beige
Beige Arizona
Beige Arizona



Noisette
Noisette
Noisette
Noisette



Safari
Safari
Safari
Safari



Rame
Copper
Cuivre
Cobre



Rosso Jaipur
Jaipur red
Rouge Jaipur
Rojo Jaipur



Bronzo
Bronze
Bronze
Bronce



Blu notte
Night blue
Bleu nuit
Azul noche



Grigio Bromo
Bromo grey
Gris Bromo
Gris Bromo



Ardesia
Ardesia
Ardesia
Pizarra



Verde Comodoro
Comodoro green
Vert Comodoro
Verde Comodoro



Nero
Black
Noir
Negro

Ambiente e sicurezza | Environment and safety | Environnement et sécurité | Medio ambiente y seguridad

Auraa Design utilizza per i suoi prodotti e i suoi imballi materiali facilmente separabili e riciclabili.
Nella produzione dei suoi manufatti, Auraa Design si impegna ad utilizzare materiali legnosi FSC e pannelli a base di legno con certificazione CARB2. I pannelli CARB2 presentano un rilascio di formaldeide inferiore rispetto al pannello E1 comunemente utilizzato (classe E1 secondo il DM 10/10/2008).

Auraa Design uses materials that are easy to separate and recycle for its products and packaging.
Auraa Design is committed to using FSC wood-based materials and CARB2-certified wood-based panels.
CARB2 panels have a lower formaldehyde release than the commonly used E1 panel (class E1 according to DM 10/10/2008).

Auraa Design utilise des matériaux facilement séparables et recyclables pour ses produits et ses emballages.
Dans la production de ses produits, Auraa Design s'engage à utiliser des matériaux en bois FSC et des panneaux à base de bois avec la certification CARB2. Les panneaux CARB2 dégagent moins de formaldéhyde que le panneau E1 couramment utilisé (classe E1 selon DM 10/10/2008).

Para sus productos y embalajes, Auraa Design utiliza materiales fácilmente separables y reciclables.
En la fabricación de sus productos, Auraa Design se compromete a utilizar materiales de madera FSC y paneles de madera con certificación CARB2. Los paneles CARB2 tienen una menor liberación de formaldehído que el panel E1 comúnmente utilizado (clase E1 según DM 10/10/2008).

Art director

Mirto Antonel

Product design

Mirto Antonel

AC/CACD/AF

Le immagini dei prodotti visibili all'interno di questo catalogo sono inserite a scopo puramente indicativo
The images of the products visible in this catalogue are included for information purposes only
Les images des produits visibles dans ce catalogue sont incluses à titre informatif uniquement
Las imágenes de los productos visibles en este catálogo se incluyen sólo con fines informativos

auraa
design



Hub Spaces, 582 Honeypot Lane, Stanmore, HA7 1JS, UK
www.auraadesign.co.uk
020 3915 8008
info@auraadesign.co.uk