

aura  
design

[www.auraadesign.co.uk](http://www.auraadesign.co.uk)

BELLA

BELLA



# BELLA

## Bella desk worktops

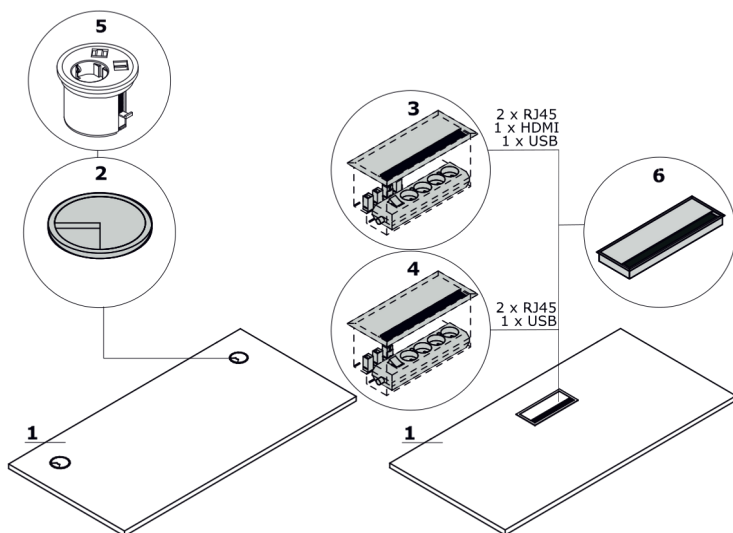

**1. Worktop** - MFC 28 mm, ABS edge

**OPTIONS WITH EXTRA CHARGE:**

**2. Grommet** - 2 pcs, Ø 80 mm

**3. Mediabox** - 2 x RJ45 (class E, cat. 6); + 1 x USB + 1 x HDMI + 4 x 230V

**4. Mediabox** - 2 x RJ45 (class E, cat. 6); + 1 x USB + 4 x 230V

**5. Mediabox** - 1 x 230V + 1 x USB charger + 1 x RJ45, colour: black, white, mounted instead of the existing grommet Ø80 mm (Pk80)

**6. Top access**

**7. Cable way** - the width of the opening is proportional to the width of the worktop

**8. Mediabox + cable grommets**

**9. Cable way + cable grommets** - desks, bench desks

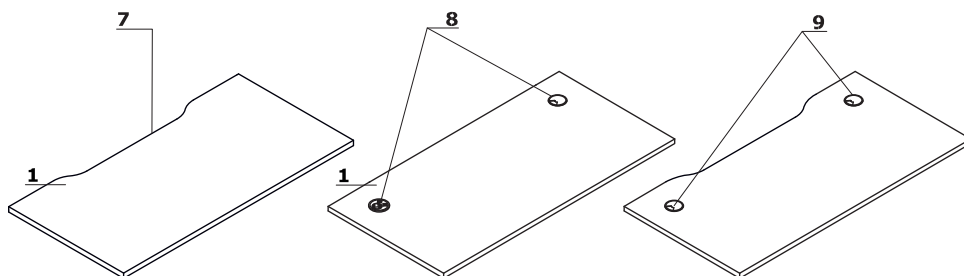

www.auraadesign.co.uk

## Frame

**Bella:** powder coated steel, profile 60x20 mm, spacer 10 mm between top and frame

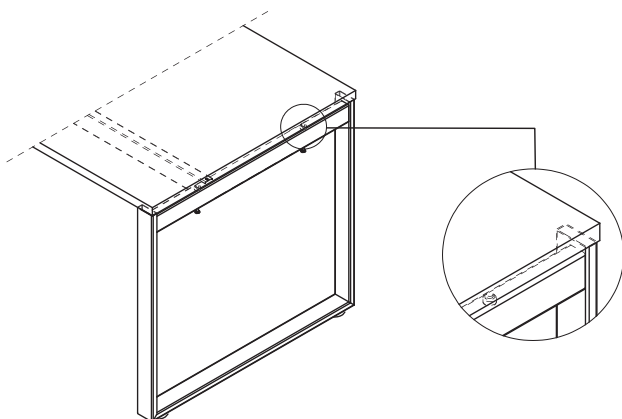

Attention - leveling - 10 mm range

Attention - cable tray under the worktop is always – aluminium semi-matt colour.

## Power strip - for series connection

1. Set for 1 workstation - power strip (3x SCHUCKO, 2x RJ45) x1 + power cord (universal outlet PL/FR/Schucko)
2. Set for 2 workstation - power strip (3x SCHUCKO, 2x RJ45) x2 + set of power cords (universal outlet PL/FR/Schucko)
3. Set for 3 workstation - power strip (3x SCHUCKO, 2x RJ45) x3 + set of power cords (universal outlet PL/FR/Schucko)

1

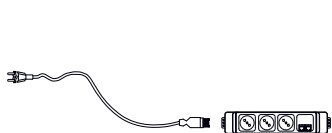

2

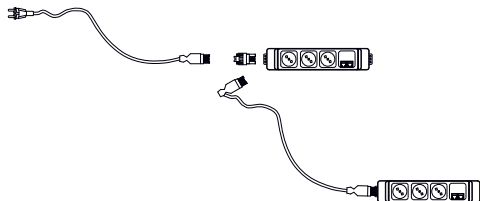

3

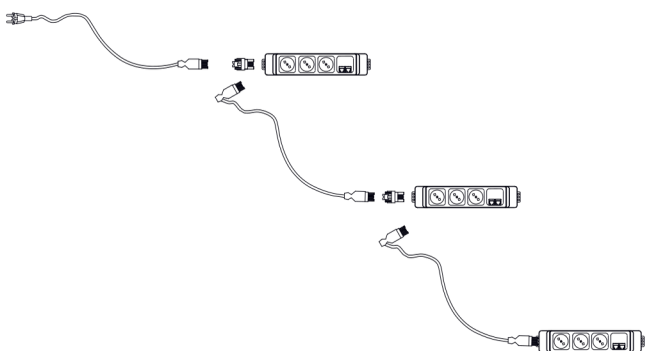

## Elements for creating desk layouts

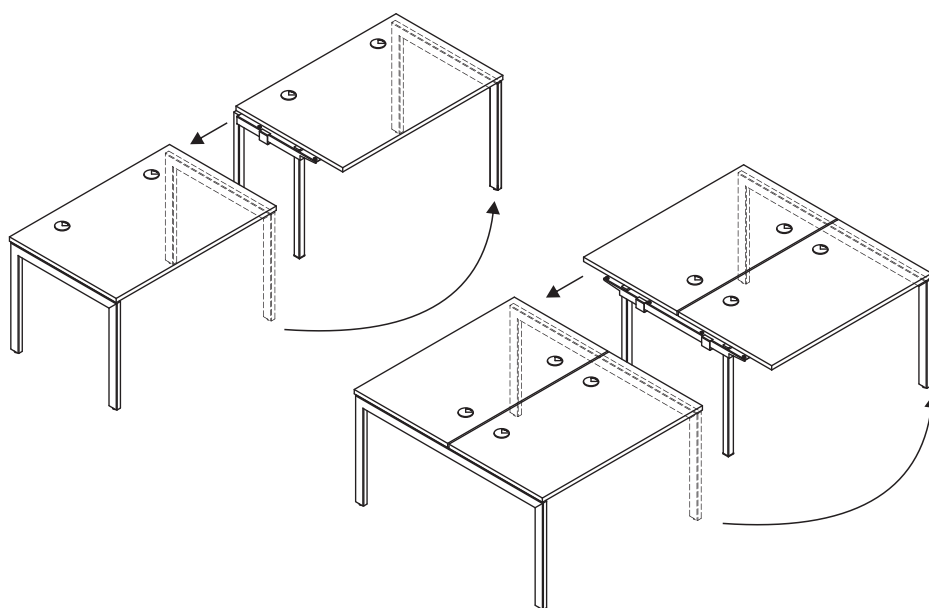

# BELLA

## Desks \*

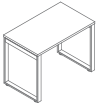

1000 / 600 / 740  
29 kg

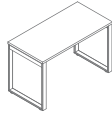

1200 / 600 / 740  
32.6 kg

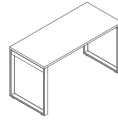

1400 / 600 / 740  
35.35 kg

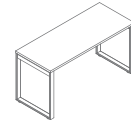

1600 / 600 / 740  
38.4 kg

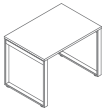

1000 / 700 / 740  
32.71 kg

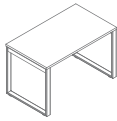

1200 / 700 / 740  
38.36 kg

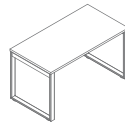

1400 / 700 / 740  
39.46 kg

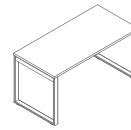

1600 / 700 / 740  
46.16 kg

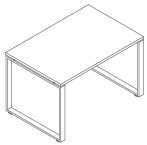

1200 / 800 / 740  
40.85 kg

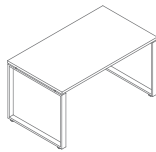

1400 / 800 / 740  
43.6 kg

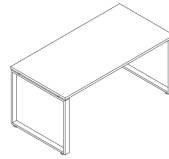

1600 / 800 / 740  
47.9 kg

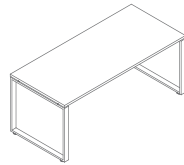

1800 / 800 / 740  
52.4 kg

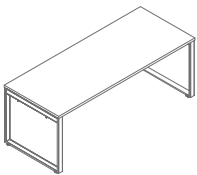

2000 / 800 / 740  
55.45 kg

# BELLA

## Elements for arrangement building - straight desk \*

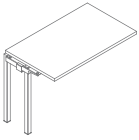

1000 / 600 / 740  
20.87 kg

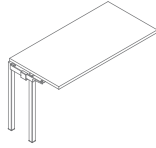

1200 / 600 / 740  
22.7 kg

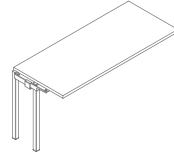

1400 / 600 / 740  
29.45 kg

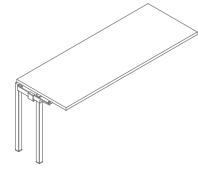

1600 / 600 / 740  
28.9 kg

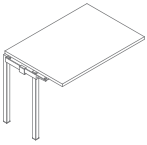

1000 / 700 / 740  
23.45 kg

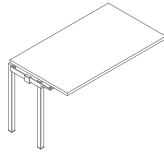

1200 / 700 /  
740 29.1 kg

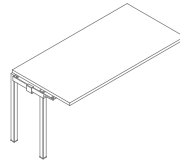

1400 / 700 /  
740 30.2 kg

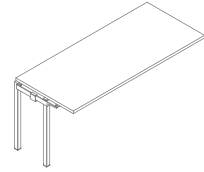

1600 / 700 / 740  
36.9 kg



500 / 800 / 740  
11 kg

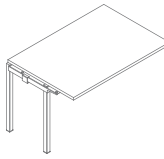

1200 / 800 / 740  
30.8 kg

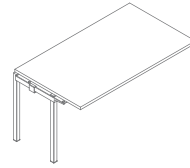

1400 / 800 / 740  
33.55 kg

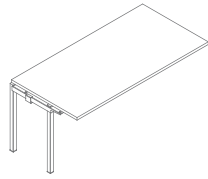

1600 / 800 / 740  
37.85 kg

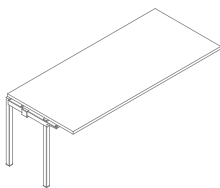

1800 / 800 / 740  
42.35 kg

\* dimensions expressed in millimetres: width x depth x height

## Bench desks \*

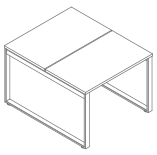

1000 / 1210 / 740  
50.8 kg

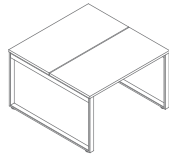

1200 / 1210 / 740  
54.6 kg

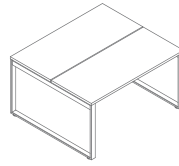

1400 / 71210 / 740  
68.1 kg

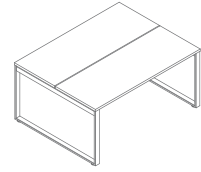

1600 / 1210 / 740  
67 kg

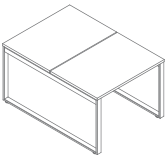

1000 / 1410 / 740  
46.22 kg

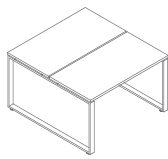

1200 / 1410 / 740  
57.52 kg

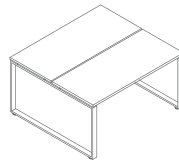

1400 / 1410 / 740  
59.72 kg

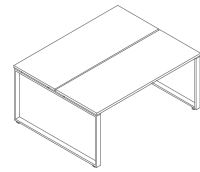

1600 / 1410 / 740  
73.12 kg

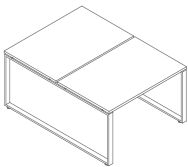

1200 / 1610 / 740  
60 kg

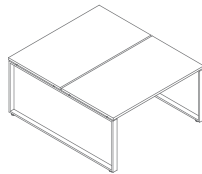

1400 / 1610 / 740  
65.5 kg

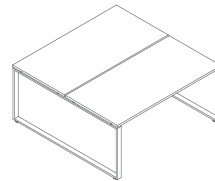

1600 / 1610 / 740  
74.1 kg

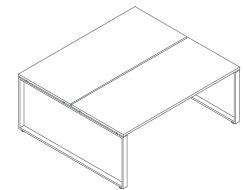

1800 / 1610 / 740  
83.1 kg

## Elements for arrangement building - bench \*

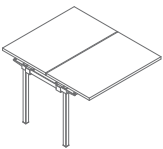

1000 / 1210 / 740  
36.8 kg

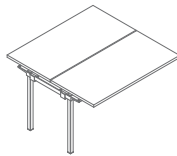

1200 / 1210 / 740  
40.6 kg

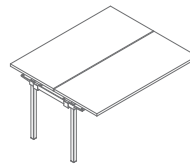

1400 / 1210 / 740  
54.1 kg

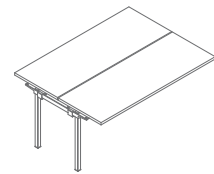

1600 / 1210 / 740  
53 kg

\* dimensions expressed in millimetres: width x depth x height

# BELLA

## Elements for arrangement building - bench \*



1000 / 1410 / 740  
24.05 kg

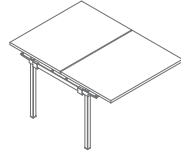

1000 / 1410 / 740  
43.7 kg

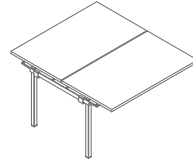

1200 / 1410 / 740  
55 kg

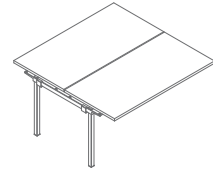

1400 / 1410 / 740  
57.2 kg

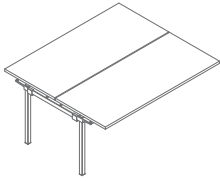

1600 / 1410 / 740  
70.6 kg



1000 / 1610 / 740  
28.75 kg

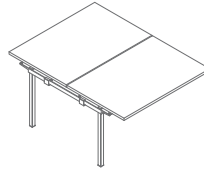

1200 / 1610 / 740  
58.35 kg

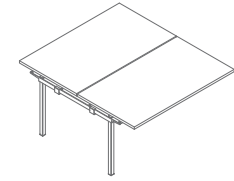

1400 / 1610 / 740  
63.85 kg

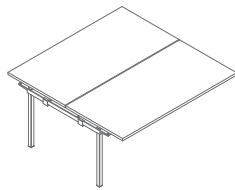

1600 / 1610 / 740  
72.45 kg

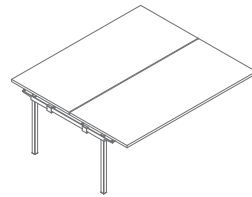

1800 / 1610 / 740  
81.45 kg

www.auraaesign.co.uk

## Desks with managerial storage \*

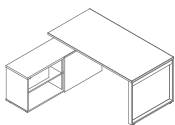

1600-1702 / 1600 / 740  
109.7 kg

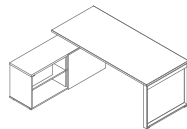

1800-1902 / 1600 / 740  
114.2 kg

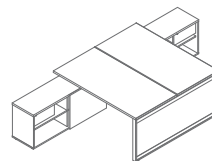

1600-1702 / 3210 / 740  
216.4 kg

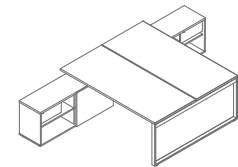

1800-1902 / 3210 / 740  
225.4 kg

\* dimensions expressed in millimetres: width x depth x height



## Desk extensions \*

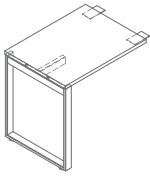

600 / 800 / 740  
18.9 kg

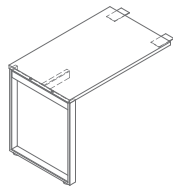

600 / 1000 / 740  
20.9 kg

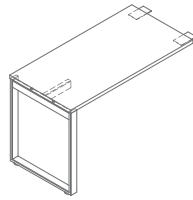

600 / 1200 / 740  
23.4 kg

## Power strip



500 / 430 / 569  
1.1 kg



500 / 430 / 569  
1.6 kg

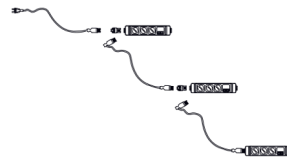

500 / 430 / 569  
2.1 kg

## Worktop, top, base, body, front



Aluminum satinato



Canadian oak



Polar birch



Cocoa



Natural oak



Honey oak



Acacia



White pastel



Dark walnut

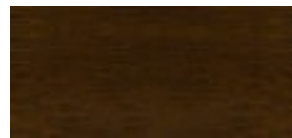

Lowland walnut



Anthracite



Black



Grey oak

www.auraaadesign.co.uk

## Frame - metal



Aluminum semi-matt



White semi-matt



Antracite semi-matt



Black semi-matt



Olive semi-matt



Blue semi-matt



Brick red semi-matt



Yellow semi-matt



Beige semi-matt

## Mediabox - metal



Aluminum semi-matt



White semi-matt



Antracite semi-matt



Black semi-matt

## Grommets



Grey



Black



Beige

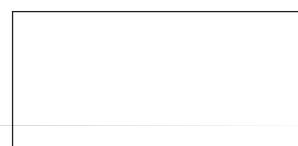

White pastel

## Accessories



Aluminum semi-matt



White semi-matt



Black semi-matt

# aura design



Hub Spaces, 582 Honeypot Lane, Stanmore, HA7 1JS, UK  
[www.auraadesign.co.uk](http://www.auraadesign.co.uk)  
020 3915 8008  
[info@auraadesign.co.uk](mailto:info@auraadesign.co.uk)