

aura  
design

Baali

---



**Desk Baali**



Baali is a collection of modular furniture which features rectangular desks, desks with tops of different shapes, team desks - Bench desks with electric height adjustment - individual and multi-person workstations and simple conference tables with different tops.

Baali offers seven leg modules - on four straight legs with round and square cross-section, on four A- and Q-shaped legs with rectangular cross-section, and rectangular, recessed legs –F model.

The collection is completed with Lano C and Lano T modules which have two legs with square cross-section placed on a foot. The desks can also be equipped with different accessories such as upholstered, chipboard partition screens, netboxes and cable channels, as well as undesk sideboards that support the desk.

## TOP

- Chipboard coated on both sides with melamine resin with increased durability - 1st class.
- Chipboard with reduced formaldehyde emission, E1 standard.
- Top finished with 2 mm thick ABS plastic edge with 3 mm radius.
- Chipboard top 25 mm thick as standard.
- Chipboard top 18 mm thick as an option - desk 7 mm lower.
- Sliding top - as an option with a surcharge.

## FRAME

- 4 legs frame with rectangular cross-section 60x30 mm.
- A-shaped legs at an angle of 90.
- Self-supporting steel structure comprising of welded elements (legs forming the side of the station) joined with beams.
- L-shaped desks are equipped with an extra middle leg with a rectangular cross-section and 60x30 mm.

## HEIGHT ADJUSTMENT

- Fixed height 740 mm and leveling feet +10 mm
- 650-850 mm height adjustment in 10 mm increments and leveling feet +10 mm.



## LEG DESK Baali

650-850 mm height adjustment in 10 mm increments and leveling feet +10 mm.

Baali top A,B,C

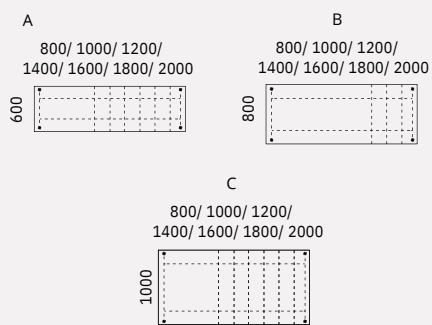
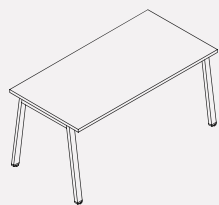

Baali top D

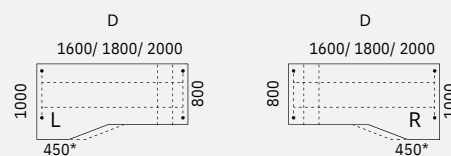
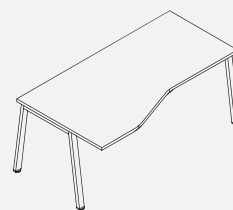

Baali top Z

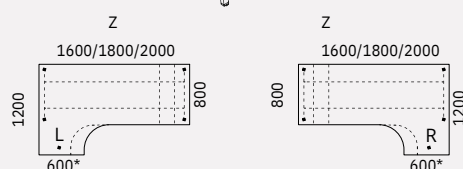
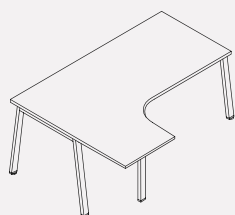

Baali top E

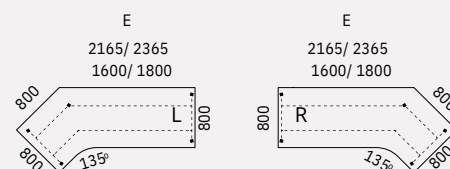
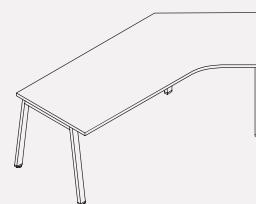

\*Niezależna noga, przykręcana bezpośrednio do blatu - 1 szt.

Baali top ZZ

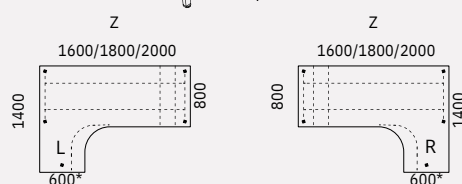
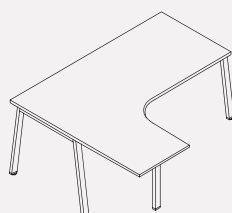

Baali top S

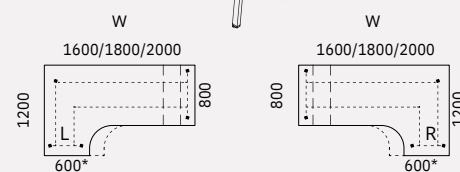
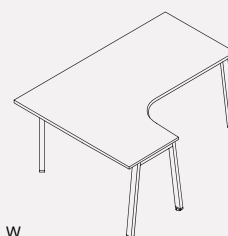

Baali top W

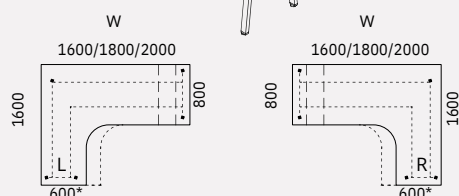
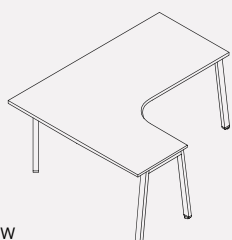

# Baali /Equipment

## Sliding top

A sliding top makes it easier to access a horizontal cable channel. In individual desks, the sliding top is optional, in team desks it comes as standard.

- The top is equipped with a slide lock which can be released with a single click.
- The sliding top comes in a set with a fold-down cable channel.
- Possibility to mount a sliding top only in 600 mm to 1000 mm deep desks.

It is possible to fit a suspended front partition screen. It is necessary to clearly indicate the sliding top option while making an order as it affects the structure of the desk.

- Sliding range 120 mm.
- Recommended accessories - brush cable outlet.

Sliding top does not constitute a part of basic desk equipment.

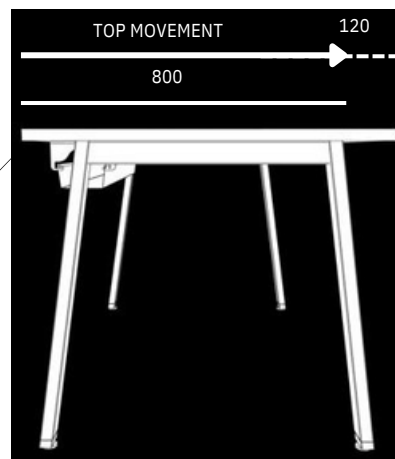

## Desk supported on sideboard

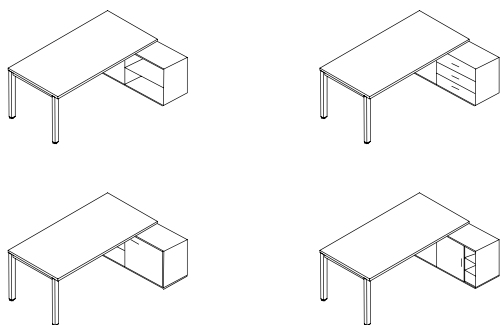

Sideboard for desk support is slid under 2/3 of the desk.

Sliding top and effortless access to fold-down cable channel still available.

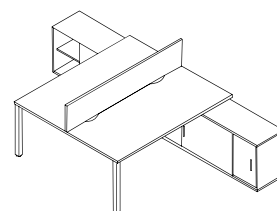

Baali desks can be supported on sideboards. It is possible to choose add-on shelf units, cabinets with two-sided sliding doors and drawers.

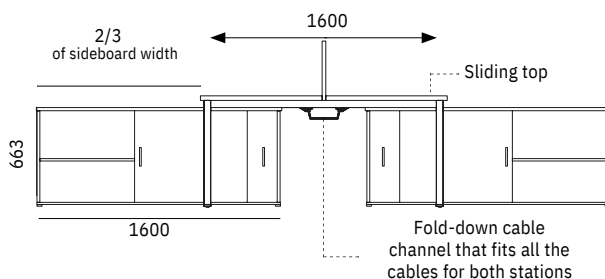



# Baali / Colours

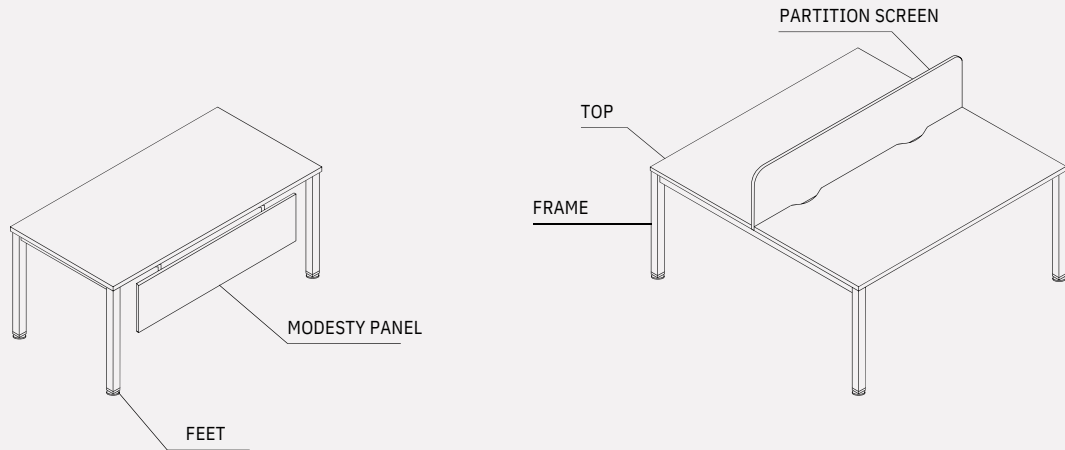

		Top 18 mm	Top 25 mm	Modesty panel	Partition screen	FRAME	FEET	Upholstered partition screen	
STANDARD	Melamina UNI	STD 1 White	•	•	•	•			
		STD 2 High Gloss White							
		STD 3 Gray	•	•	•	•			
		STD 4 Beige	•	•	•	•			
		STD 5 Norwegian Green	•	•	•	•			
		STD 6 Navy Blue	•	•	•	•			
		STD 7 Graphite	•	•	•	•			
		STD 8 Black	•	•	•	•			
	Melamine	STD 10 Acacia	•	•	•	•			
		STD 11 European Maple	•	•	•	•			
		STD 12 Napolitano Oak	•	•	•	•			
		STD 13 Gray Spruce	•	•	•	•			
		STD 14 American Oak	•	•	•	•			
		STD 15 Natural Oaky	•	•	•	•			
		STD 16 Cherry Havana	•	•	•	•			
		STD 17 Walnut Brown	•	•	•	•			
		TREND*	Melamine	TRD 1 Blush	•		•	•	
TRD 2 Claret	•				•	•			
TRD 3 Dark Turquoise	•				•	•			
TRD 11 Stark Oak	•				•	•			
TRD 12 Flamed Oak	•				•	•			
STANDARD	Metal	M 02 White				•			
		M 01 Aluminium				•			
		M 03 Beige				•			
		M 05 Graphite				•			
		M 04 Black				•			
TREND*		M 06 Sunny Beige				•			
		M 09 Dirty Pink				•			
		M 08 Ginger				•			
		M 07 Faded Turquoise				•			
ABS Metal		Black					•		
1st GROUP	Caldo	LC1						•	
		LC2						•	
		LC5						•	
		LC6						•	
		LC11						•	
		LC13						•	
		LC14						•	
		LC16						•	
		LC17						•	
	Terra	LT4						•	
		LT5						•	
		LT10						•	
		LT14						•	
		LT3						•	
									•
	2nd GROUP	Synergy	CS45						•
			CS44						•
			CS46						•
			CS49						•
CS56								•	
CS74								•	
CS73								•	
CS79								•	
CS59								•	
CS62								•	
CS08						•			
CS16						•			
3rd GROUP	Synergy Quilt	CSI08						•	
		CSV08						•	
		CSI59						•	
		CSV59						•	

# Melamine

① STANDARD



② TREND



# Metal

① STANDARD

② TREND

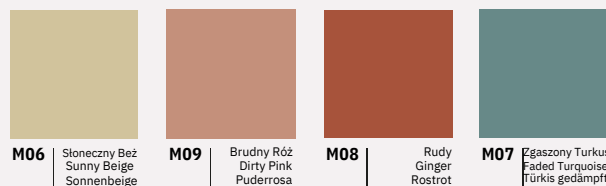
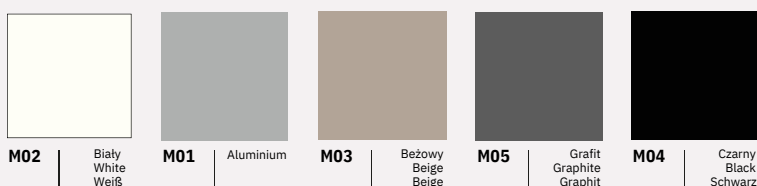

# Fabrics

100% Polyester  
100.000 Martindale cycles

① CALDO  
Select by Lech



95% Virgin Wool, 5% Poliamid  
100.000 Martindale cycles

② SYNERGY  
Camira



100% Recycled Polyester  
67.000 Martindale cycles

① TERRA  
Select by Lech

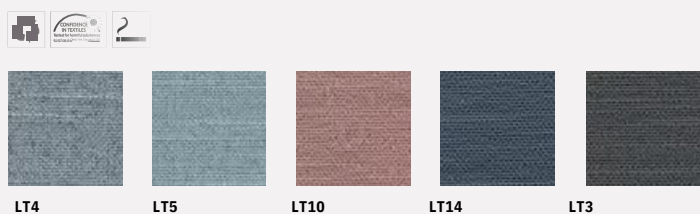



# aura design



Hub Spaces, 582 Honeypot Lane, Stanmore, HA7 1JS, UK  
[www.auraadesign.co.uk](http://www.auraadesign.co.uk)  
020 3915 8008  
[info@auraadesign.co.uk](mailto:info@auraadesign.co.uk)