

aura  
design

Azura

---



## Cabinets and Showcases

# Azura Storage

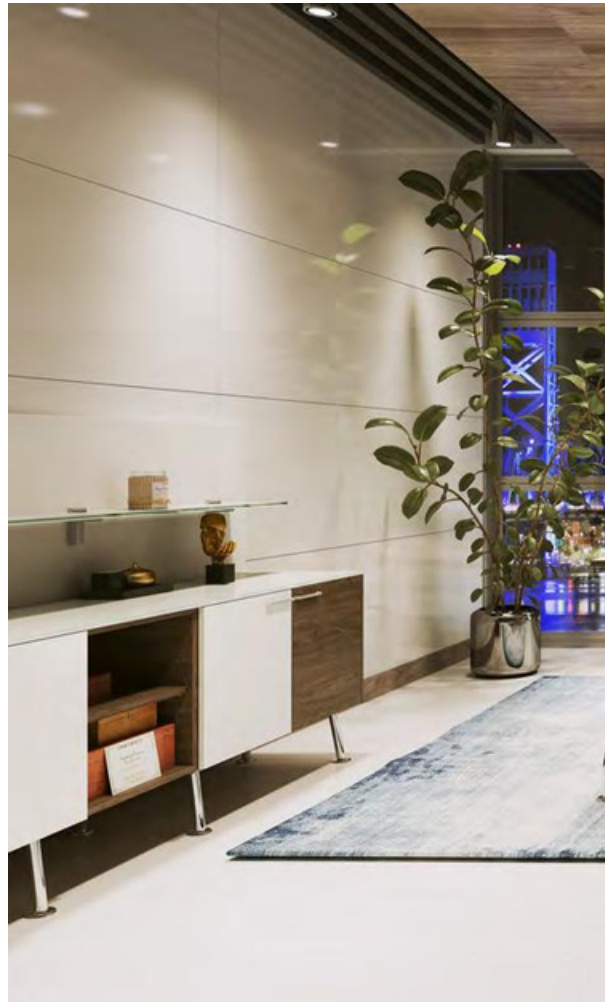

Azura collection features individual and team desks as well as conference and occasional tables. Cabinets and showcases complement the collection - everything you need to completely furnish your office.

The furniture's distinctive feature is a unique, slim shape of legs. A wide range of sideboards for desks support helps to adapt the space to your needs.

## STRUCTURE

### CARCASS

- 18 mm thick board carcass in UNI color. -Chipboard coated on both sides with melamine resin with increased durability - 1st class.
- Chipboard with reduced formaldehyde emission, E1 standard.
- Showcase carcasses are factory-glued, assembled and delivered as a whole.
- Carcass finished with 2 mm thick ABS plastic edge with 3 mm radius.

## EQUIPMENT

- All shelves are equipped with a mechanism preventing accidental pull out.
- Possibility to manage the interior space individually thanks to hole spacing (every 32 mm) over the entire height of sides.
- Hinged doors are equipped with C1 handles as standard. Push to Open system as an option with no surcharge.
- Showcases based on 200 mm high, powder coated legs, or chromium plated legs as an option with a surcharge.



### BACK WALL

- 8 mm thick back wall recessed into the groove between the sides of the cabinet.
- Back wall is coated on both sides with melamine resin, thanks to which the cabinet can stand independently.



# Azura / Showcases

Azura narrow executive showcase

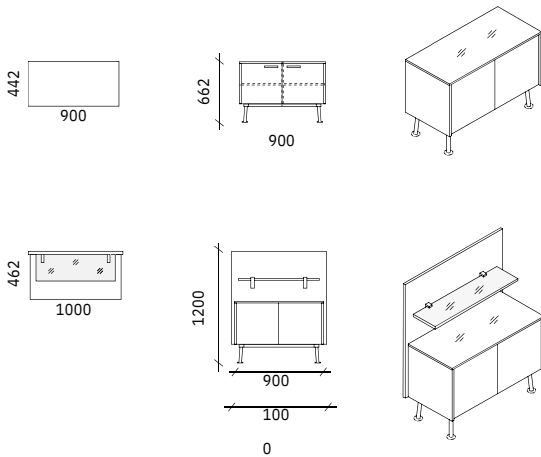

Azura narrow executive showcase with open segment

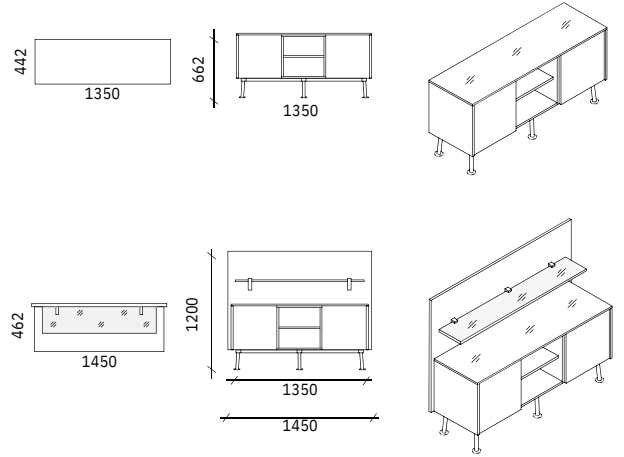

Azura medium executive showcase

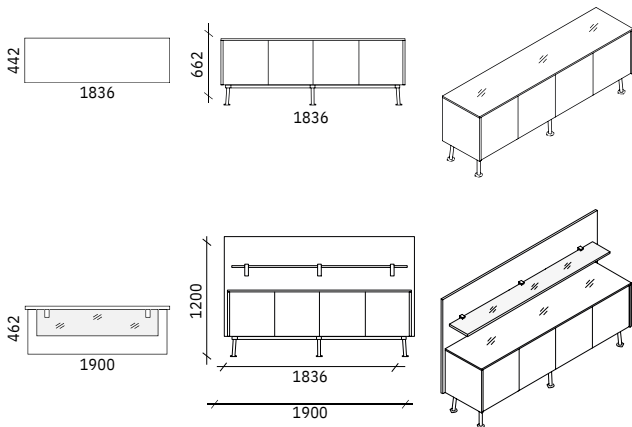

Azura wide executive showcase with open segment

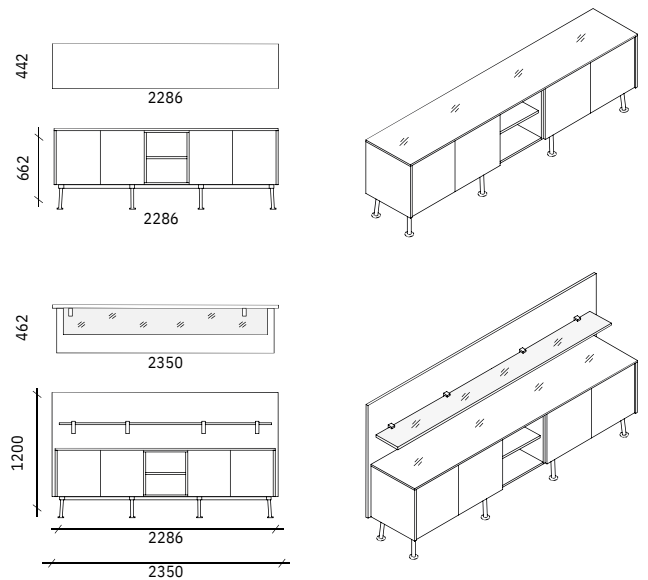

# Azura / Cabinets

Azura low cabinet

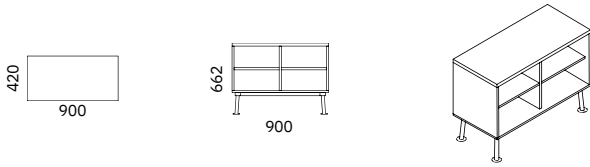

Azura low closed cabinet

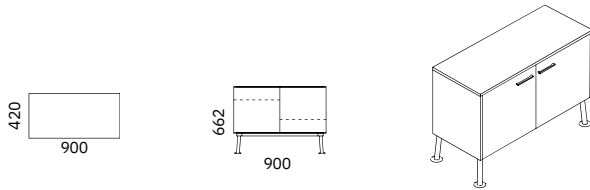

Azura low cabinet with drawer

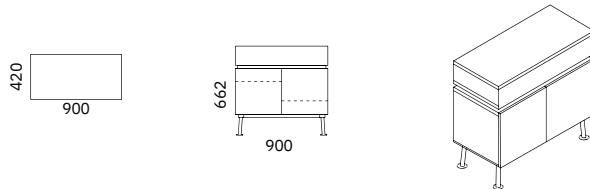

Azura middle cabinet

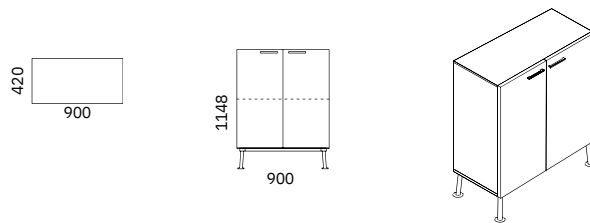

Azura high cabinet with open top segment

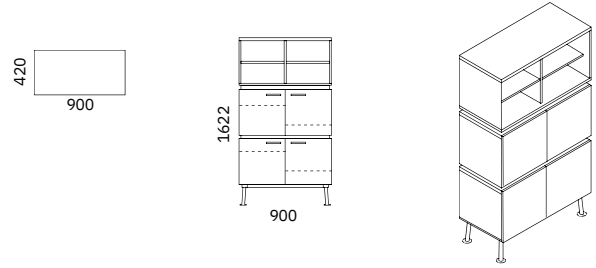

Azura high cabinet

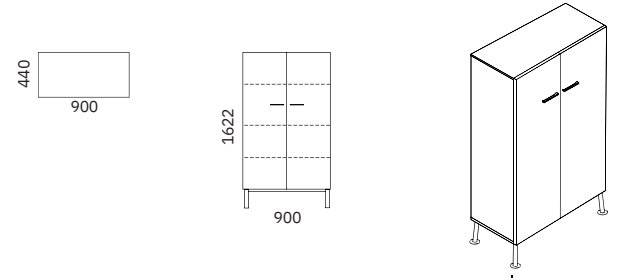

Azura cabinet for documents

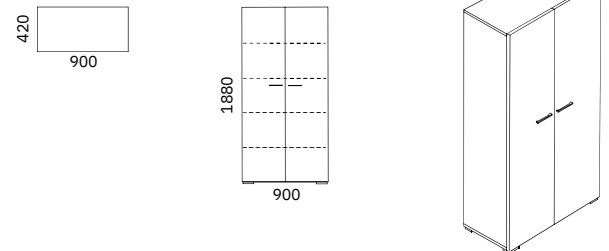

Azura high cabinet with open middle segment

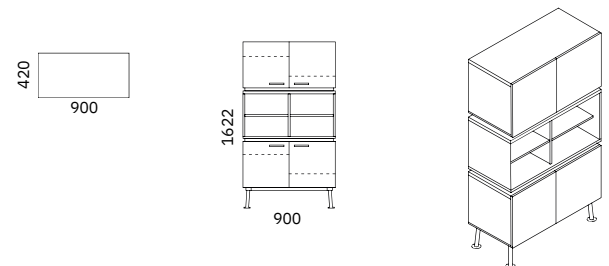

Azura cabinet for documents and clothes

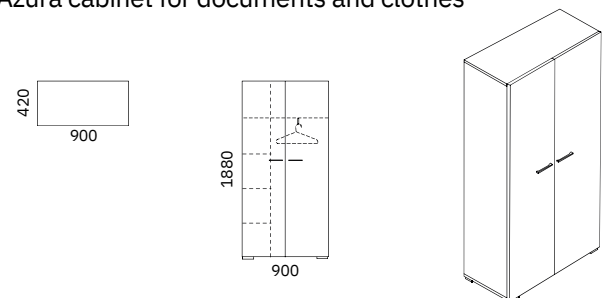

# Azura / Features

## Cabinets and showcases - details

Self feed drills

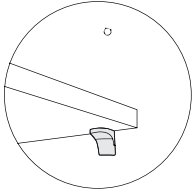

Shelves with a mechanism preventing accidental pull out.

Leg

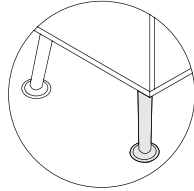

Powder-coated with chromium plated foot.

Drawer

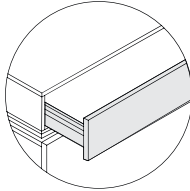

With Soft Close Automatic mechanism and Push to Open system as standard. Graphite drawer interior.

Handle C1

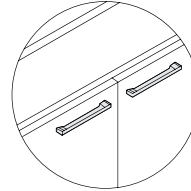

In mat chromium colour, 128 mm wide, Push to Open system as an option with no surcharge.

Decorative inlay

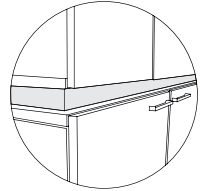

White or graphite

Glass shelf

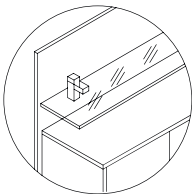

12 mm thick glass shelf for back panel as standard.

Back panel

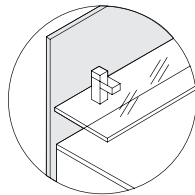

Made of 18 mm thick board enabling to mount a glass shelf.

Chromium plated feet inlays

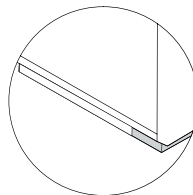

H= 30 mm

Glass top cladding

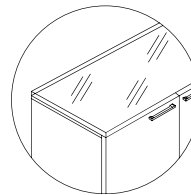

Glass top cladding on credenza

## Showcases

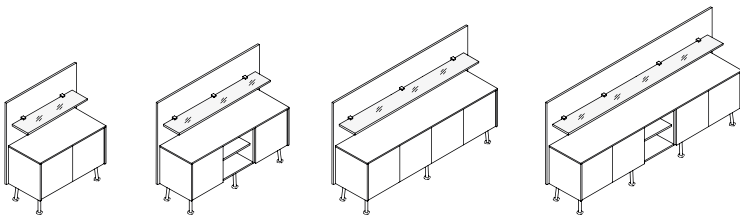

## Cabinets

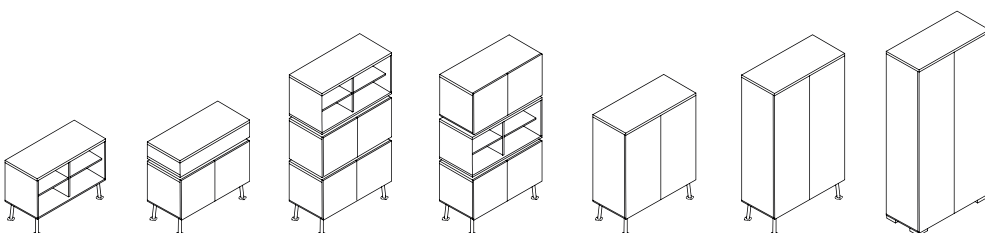

# Azura / Colours

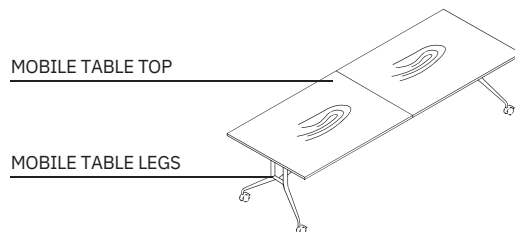
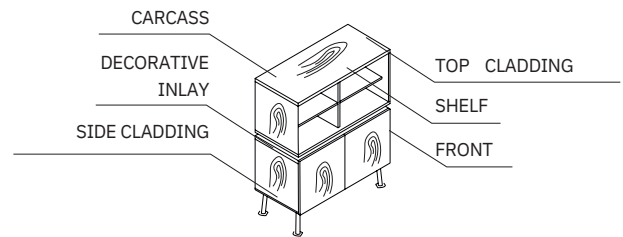
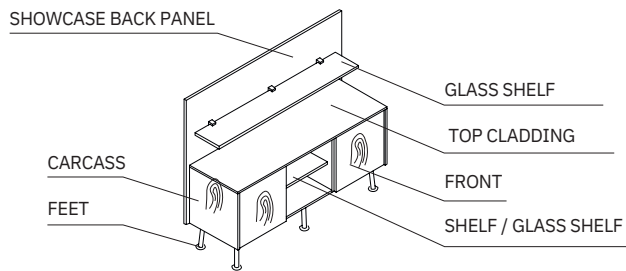
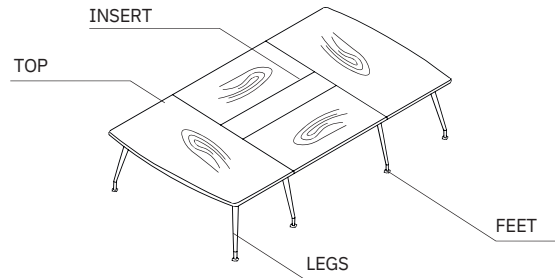
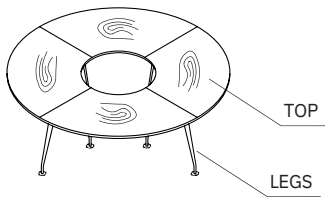
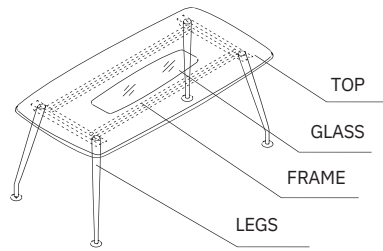
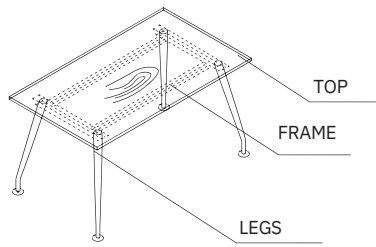



# Azura / Colours

		Top 18mm	Top 25 mm	Insert	Frame	Legs	Front	Shelf	Carcass and shelf	Decorative inlay	Feet	Back panel	Side cladding	Top cladding	Glass shelf	Mobile table top	Mobile table legs	
STANDARD	Melamine UNI	STD 1	White	•	•				•	•		•				•		
		STD 2	High Gloss White						•									
		STD 3	Gray	•	•				•	•			•				•	
		STD 4	Beige	•	•				•	•			•				•	
		STD 5	Norwegian Green	•	•				•	•			•				•	
		STD 6	Navy Blue	•	•				•	•			•				•	
		STD 7	Graphite	•	•				•	•	•		•				•	
		STD 8	Black	•	•				•	•			•				•	
	Melamine	STD 10	Acacia	•	•				•	•			•				•	
		STD 11	European Maple	•	•				•	•			•				•	
		STD 12	Napolitano Oak	•	•				•	•			•				•	
		STD 13	Gray Spruce	•	•				•	•			•				•	
		STD 14	American Oak	•	•				•	•			•				•	
		STD 15	Natural Oaky	•	•				•	•			•				•	
		STD 16	Cherry Havana	•	•				•	•			•				•	
		STD 17	Walnut Brown	•	•				•	•			•				•	
		TREND*	Melamine	TRD 1	Blush	•				•	•			•				•
TRD 2	Claret			•				•	•			•				•		
TRD 3	Dark Turquoise			•				•	•			•				•		
TRD 11	Stark Oak			•				•	•			•				•		
TRD 12	Flamed Oak			•				•	•			•				•		
PREMIUM**	HPL	FX1	Fenix White	•	•													
		FX2	Fenix Black	•	•													
	Solid wood	RW1	Lacquered Oak		•													
		RW2	Oiled Oak		•													
	Stone	ST 1	Nero Greco	•														
		ST 2	Noir Desir	•														
		ST 3	Bianco Venato	•														
	Veneer	VR 4	Burundi Mahogany															
		VR 5	Brazilian Rosewood															
		VR 6	Flader Oak															
+		Dry-wipe board													•			
STANDARD	Glass	GL 01	Opti White													•		
		GL 02	Satinato	•												•		
		GL 03	Opti Black	•												•		
		GL 04	White Lacobel												•	•		
		GL 05	Black Lacobel												•	•		
STANDARD	Metal	M 02	White				•	•									•	
		M 01	Aluminium				•	•										
		M 03	Beige				•	•										
		M 05	Graphite				•	•										
		M 04	Black				•	•										•
TREND*		M 06	Sunny Beige															
		M 09	Dirty Pink															
		M 08	Ginger															
		M 07	Faded Turquoise															
Metal Metal		Chrome				•				•								

# aura design



Hub Spaces, 582 Honeypot Lane, Stanmore, HA7 1JS, UK  
[www.auraadesign.co.uk](http://www.auraadesign.co.uk)  
020 3915 8008  
[info@auraadesign.co.uk](mailto:info@auraadesign.co.uk)