

# Alicee

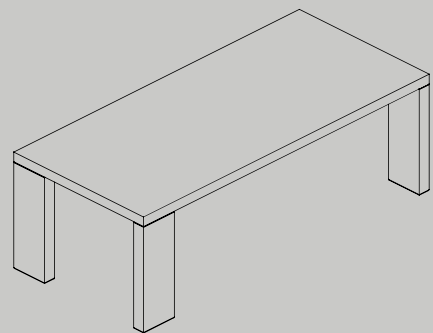

---

direzionali | executive | mobilier de direction | ejecutivos

auraa  
design



Alcee nella mitologia è una figura caratterizzata da imponenza, coraggio e potenza dovuti ad una forza così grande da superare quella, talvolta antagonista, degli dei. Alcee è la collezione direzionale di alta gamma che Auraa Design propone e che si contraddistingue per un design dai segni forti e rigorosi che tracciano le linee proprie dell'eleganza colta e raffinata.

In mythology Alcee epitomizes majesty, courage and strength derived from a power, at times greater than that of the Gods, and which was periodically used against them. Alcee is Auraa Design's very latest high end Private office collection, defined by its bold, austere and inherently elegant design.

Alcee dans la mythologie est la figure imposante caractérisée par le courage et la puissance fournis par une force tellement considérable qu'elle dépasse celle-même des dieux, parfois antagoniste. Alcee est la collection de direction de prestige proposée par Auraa Design et qui se distingue par son design aux traits forts et rigoureux qui déterminent les lignes propres à l'élégance cultivée et raffinée.

Alcee en la mitología es la figura que se caracteriza por su tamaño impresionante, valor y potencia, fruto de una fuerza tan grande que sobrepasa hasta la de los dioses. Alcee es la línea ejecutiva de alto prestigio propuesta por Auraa Design y que sobresale por su diseño de rasgos fuertes y rigurosos que determinan las líneas mismas de elegancia refinada.

# Alcee

L'eleganza del disegno si tramuta nell'attenta cura del dettaglio, nell'uso di materiali di grande qualità, nella sapiente maestria artigianale. La collezione Alcee si veste di nuove finiture in essenza legnosa quali Ebano Silver e Makassar e originali tonalità nei materiali melamminici come l'Ardesia e il Noisette. Il programma si articola in varie tipologie di tavoli: scrivanie freestanding con gambe a sezione rettangolare di mm 237X77 caratterizzate dall'innovativo assemblaggio a "schema libero" in quanto, al momento dell'aggregazione al piano, è possibile decidere la loro posizione secondo molteplici possibilità compositive che conferiscono originali e mutevoli personalità estetiche e funzionali.

The elegance of this design is expressed in our precise attention to detail, in the scrupulous use of quality materials and the unrivalled dexterity of our craftsmen. The Alcee Collection boasts 2 new wood finishes; Ebano Silver and Makassar and 2 new colors have been added to our melamine palette; Ardesia and Noisette. The collection comprises various types of tables including freestanding desks with legs that have rectangular sections of 237 mm x 77 mm. Prior to the installation of the desktop, it is possible to dramatically change both the look and functionality of the desk by modifying the direction of these rectangular legs.

L'élégance du dessin transparaît dans l'attention du détail, l'utilisation des matériaux de grande qualité, l'experte maîtrise artisanale. La collection Alcee se revêt de nouvelles finitions en essence ligneuse telles que l'ébène Silver et le makassar ainsi que de tonalités originales des matériaux mélaminés comme l'Ardoise et la Noisette. Le programme s'articule autour de diverses typologies de tables: bureaux auto-porteurs aux piètements rectangulaires de 237mm x 77mm caractérisés par l'assemblage à schéma libre en tant que, au moment de l'assemblage, il est possible de choisir leur positionnement selon de multiples possibilités qui confèrent autant de personnalités esthétiques originales et fonctionnelles.

El cuidado de los detalles, la elección de materiales de alta calidad y la experta artesanía resaltan la elegancia del diseño. La colección Alcee se viste con nuevos acabados en maderas tales como Ebano Silver y Makassar, así como nuevas tonalidades de melaminas como Ardesia y Noisette. El programa se declina en varias tipologías de mesas: escritorios auto-portantes con patas de sección rectangular de 237mm x 77mm que se caracterizan por su gran modularidad de ensamblaje: al armar la superficie es posible ubicarlas de varias maneras creando múltiples composiciones de varias y originales personalidades estéticas y funcionales.







# Alcee 3

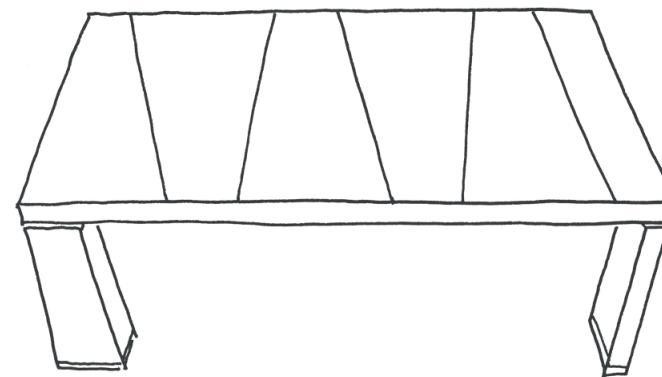

É possibile arricchire funzionalmente la postazione di lavoro, aggregando alla scrivania un mobile contenitore laterale oppure dotandola di un piano dattilo capace di aumentare notevolmente la superficie operativa. Oltre ai piani in essenza legnosa Ebano Silver e Makassar, Alcee prevede piani rivestiti in cuoio con cuciture a vista di elementi dalla forma di trapezi o di poligoni irregolari e tali originali composizioni sono dettate dalla volontà progettuale, di utilizzare al massimo grado consentito, gli sfridi di lavorazione del cuoio: ecco un concreto esempio di “eco-disegno”. In abbinamento ai tavoli vengono proposte consolle in legno con struttura a ponte: libere, o dotate di contenitore con antine quadrate.

The functionality of the workspace can be greatly enhanced by adding a mobile lateral storage unit to the desk or adding a return which greatly increases the size of the worksurface. In addition to worksurfaces in Silver Ebano and Makassar, Alcee desks are also available in leather with stitching in trapezoid or polygon patterns. In this way, leather remnants can be stitched together in a very original pattern, creating a genuine example of “eco-design”. Free-standing consoles fitted with square doors and “bridge” consoles that attach to bookcases complete the collection of tables and desks.

Il est possible d’enrichir fonctionnellement la position de travail, en ajoutant au bureau un meuble latéral ou bien un retour qui augmente sensiblement la surface de travail. Outre les plans en essence Ebène Silver ou Makassar, Alcee propose aussi des revêtements en cuir sur-piqué aux formes trapézoïdales ou en polygones irréguliers; de telles compositions originales sont dictées par la volonté conceptuelle de réemployer au maximum les chutes du travail du cuir: voici un exemple concret de “eco-design”. En complément des tables il est proposé aussi des consoles en bois avec structure en pont: libres ou bien dotées d’étagères à portes carrées.

Es posible enriquecer las funciones de los puestos de trabajo, añadiendo un mueble/archivo lateral al escritorio o conectando un ala que aumenta considerablemente la superficie de trabajo. Además de los topes en maderas Ebano Silver y Makassar, Alcee ofrece también superficies cubiertas en cuero con costuras a vista de elementos con formas de trapezoides o de polígonos irregulares y tales composiciones originales derivan de la voluntad de usar al máximo los desperdicios de los trabajos del cuero: así se nota un ejemplo concreto de “eco-diseño”. En complemento a las mesas se proponen credenzas en madera con estructura puente: liberadas o conjuntas a estanterías con puertas cuadradas.





Il mobile laterale integrato alla scrivania, si compone di una scocca in materiale melamminico e di un'anta scorrevole con rivestimento ligneo. Il contenitore è provvisto di cassetti, classificatori, vani a giorno, di uno spazio porta cpu e dei necessari elementi tecnici dedicati al passaggio dell'elettrificazione.

The desk's integrated lateral storage unit has a melamine shell with a sliding door in contrasting wood. The storage unit offers drawers, open compartments, sections for files and a cpu holder which enables wire access from the desktop.

Le meuble latéral intégré au bureau se compose d'une structure en mélaminé et d'une porte coulissante en bois. Il est fourni de tiroirs, classeurs, élément ouvert et d'une espace pour l'unité centrale ainsi que des éléments nécessaires au câblage.

El mueble lateral combinado con el escritorio se compone de un casco en melamina y una puerta corrediza en madera. Incluye gavetas, clasificadores, estantes abiertos y porta-CPU así como los elementos técnicos para el cableado.



Alcee





Le piccole riunioni trovano luogo utilizzando tavoli con basamenti in acciaio cromato e piani tondi o quadrati. Questi ultimi possono essere rivestiti in pelle con cuciture a vista, impreziositi da un originale design che nasce dall'utilizzo di forme geometriche irregolari e sempre diverse.

Small meeting tables are available with either round or square tops and a chrome steel base. The tables can be upholstered in leather with exposed stitching and further embellished with original designs using irregular geometric shapes.

Les petites réunions sont accueillies autour des tables à piètement en acier chromé et aux surfaces rondes ou carrées. Ces dernières peuvent aussi être recouvertes de cuir sur-piqué, soulignées par un dessin original fruit des formes irrégulières et toujours uniques.

Las pequeñas juntas aprovechan de las mesas con bases en acero cromado y superficies redondas o cuadradas. Estas pueden cubrirse de piel con costuras visibles, enriquecidas por un diseño original de formas geométricas irregulares y siempre únicas.





# Alcee 1





I piani di forte spessore sono realizzati con un innovativo materiale stratificato, capace di conferire al manufatto alta resistenza meccanica e un peso dal valore contenuto. Allo scopo di utilizzare la minor quantità di materiale possibile, le gambe dei tavoli al loro interno sono cave e ciò si è reso possibile grazie all'utilizzo di tecnologie produttive all'avanguardia.

Thick panels are made of an innovative, stratified material, which increases their mechanical resistance. Thanks to our technological advances, the use of materials is kept to a minimum allowing our table legs to be hollow.

Les plans de forte épaisseur utilisent un matériau stratifié innovant, qui leur confère haute résistance mécanique tout en maintenant un poids raisonnable. Afin d'employer le moins de matière possible, les pieds sont creux, ce qui est rendu possible grâce à de nouvelles technologies productives d'avant-garde.

Los topos muy gruesos son de un material estratificado innovador que les confiere alta resistencia en un peso aceptable. Gracias a tecnologías productivas de vanguardia y para disminuir la cantidad de material necesario, las patas de las mesas son huecas.

# Alcee 2





# Alcee 2







# Alcee 2





Ogni tipologia strutturale nella quale Alcee si configura prevede la soluzione del contenimento e del passaggio dell'elettrificazione.

All Alcee structural storage units provide wire management and access solutions.

Chaque typologie structurale dans laquelle se décline Alcee prévoit la solution de rangement ou du passage de câbles.

Cada tipología estructural en la cual se configura Alcee prevé la solución de almacenaje y del cableado.

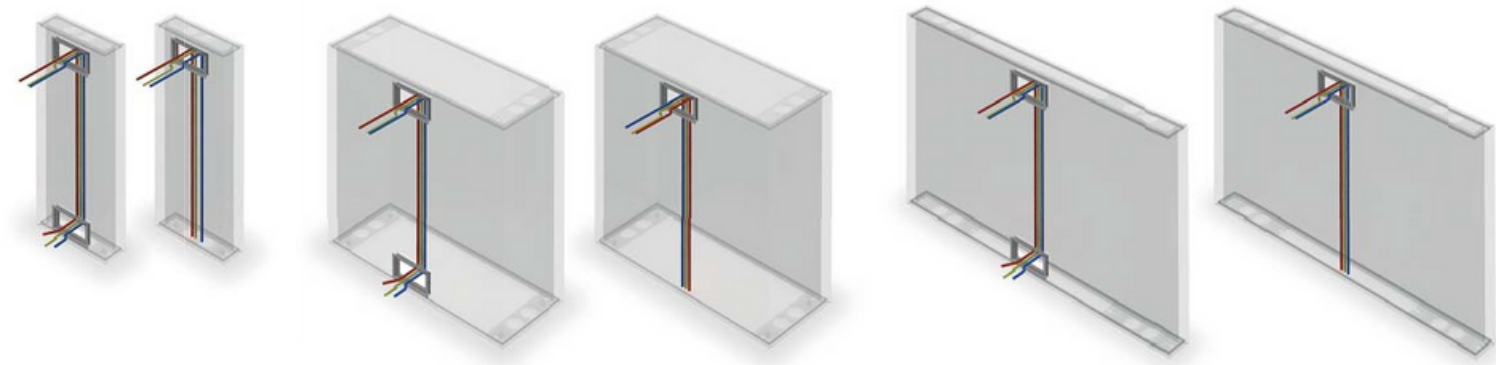

**SCRIVANIA RETTANGOLARE P.100 (H.73,4)**  
 Rectangular desk D.36 6/16" (H.28 14/16") - Bureau rectangulaire P.100 (H.73,4)  
 Mesa rectangular P.100 (H.73,4)

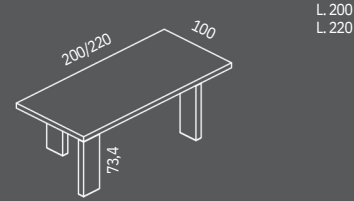

L. 200  
L. 220

**SCRIVANIA RETTANGOLARE P.100 (H.73,4)**  
 Rectangular desk D.36 6/16" (H.28 14/16") - Bureau rectangulaire P.100 (H.73,4)  
 Mesa rectangular P.100 (H.73,4)

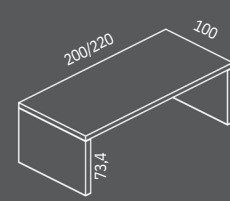

L. 200  
L. 220

**DATTILO AGGANCIATO P. 60 (H.73,4)**  
 Hanged return D.23 10/16" (H.28 14/16") - Retour accroché P.60 (H.73,4)  
 Ala suspendida P.60 (H.73,4)

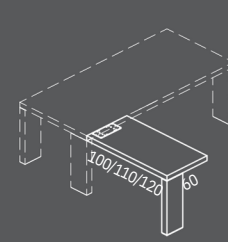

L. 100  
L. 110  
L. 120

**TAVOLI RIUNIONE P.180 (H.73,4)**  
 Conference table D.70 14/16" (H.28 14/16") - Tables de réunion P.180 (H.73,4)  
 Mesas de juntas P.180 (H.73,4)

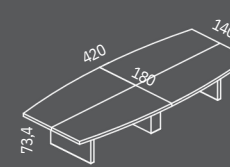

L. 420

**TAVOLI RIUNIONE P.180 (H.73,4)**  
 Conference table D.70 14/16" (H.28 14/16") - Tables de réunion P.180 (H.73,4)  
 Mesas de juntas P.180 (H.73,4)

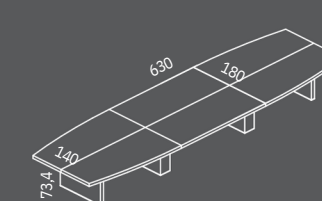

L. 630

**TAVOLI RIUNIONE P.180 (H.73,4)**  
 Conference table D.70 14/16" (H.28 14/16") - Tables de réunion P.180 (H.73,4)  
 Mesas de juntas P.180 (H.73,4)

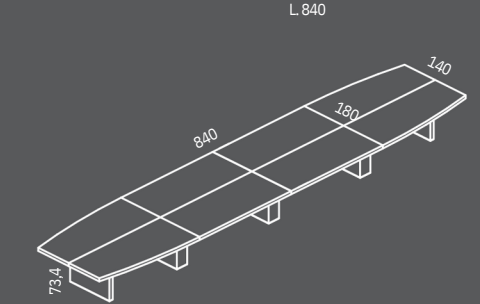

L. 840

**DATTILO AGGANCIATO P. 60 (H.73,4)**  
 Hanged return D.23 10/16" (H.28 14/16") - Retour accroché P.60 (H.73,4)  
 Ala suspendida P.60 (H.73,4)

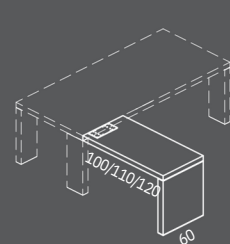

L. 100  
L. 110  
L. 120

**MODESTY**  
 Modesty panel - Voile de fond - Faldón

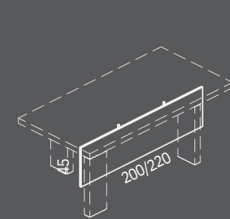

L. 200  
L. 220

**MODESTY**  
 Modesty panel - Voile de fond - Faldón

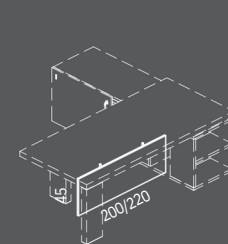

L. 200  
L. 220

**TAVOLINI P.60 (H.40)**  
 Coffee table D. 23 10/16" (H.15 12/16") - Tables basse P.60 (H.40)

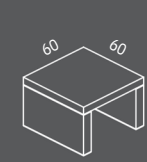

L. 60

**TAVOLINI P.60 (H.40)**  
 Coffee table D. 23 10/16" (H.15 12/16") - Tables basse P.60 (H.40)

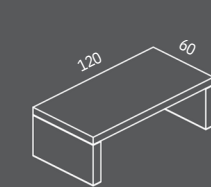

L. 120

**CONSOLE P.60 (H.82)**  
 Free-standing console D. 23 10/16" (H.32 5/16") - Console P.60 (H.82)  
 Console P.60 (H.82)

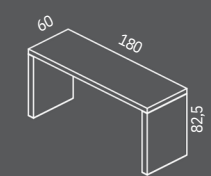

L. 180

**TAVOLI RIUNIONE P.120 (H.73,4)**  
 Conference table D.47 4/16" (H.28 14/16") - Tables de réunion P.120 (H.73,4)  
 Mesas de juntas P.120 (H.73,4)

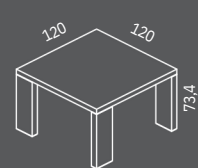

L. 120

**TAVOLI RIUNIONE P.120 (H.73,4)**  
 Conference table D.47 4/16" (H.28 14/16") - Tables de réunion P.120 (H.73,4)  
 Mesas de juntas P.120 (H.73,4)

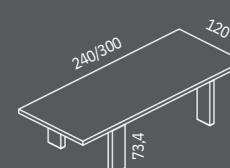

L. 240  
L. 300

**TAVOLI RIUNIONE P.120 (H.73,4)**  
 Conference table D.47 4/16" (H.28 14/16") - Tables de réunion P.120 (H.73,4)  
 Mesas de juntas P.120 (H.73,4)

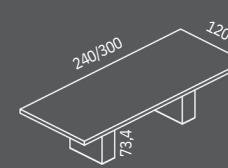

L. 240  
L. 300

**CONSOLE P.60 (H.82)**  
 Free-standing console D. 23 10/16" (H.32 5/16") - Console P.60 (H.82)  
 Console P.60 (H.82)

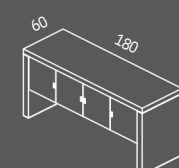

L. 180

**MOBILE DI SERVIZIO P.63 (H.66)**  
 Lateral storage unit D. 24 13/16" (H.26) - Meuble retour P.63 (H.66)  
 Mueble de servicio P.63 (H.66)

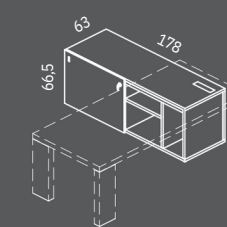

L. 178

**MOBILE DI SERVIZIO P.63 (H.66)**  
 Lateral storage unit D. 24 13/16" (H.26) - Meuble retour P.63 (H.66)  
 Mueble de servicio P.63 (H.66)

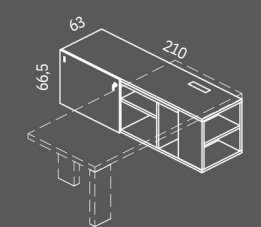

L. 210

**TAVOLI RIUNIONE P.120 (H.73,4)**  
 Conference table D.47 4/16" (H.28 14/16") - Tables de réunion P.120 (H.73,4)  
 Mesas de juntas P.120 (H.73,4)

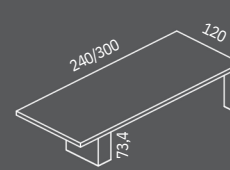

L. 240  
L. 300

**TAVOLI RIUNIONE P.120 (H.73,4)**  
 Conference table D.47 4/16" (H.28 14/16") - Tables de réunion P.120 (H.73,4)  
 Mesas de juntas P.120 (H.73,4)

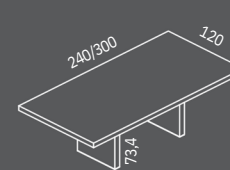

L. 240  
L. 300

**TAVOLI RIUNIONE D.120 (H.73,4)**  
 Round table 47 4/16" (H.28 14/16") - Tables de réunion D.120 (H.73,4)  
 Mesas redondas D.120 (H.73,4)

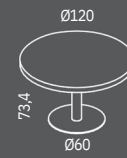

D.120

**CASSETTIERA P.56 (H.35)**  
 Drawers unit D. 22 1/16" (H.13 12/16") - Bloc tiroirs P.56 (H.35)  
 Buc de cajones P.56 (H.35)

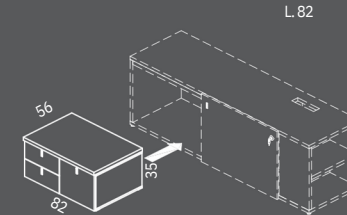

L. 82

**RIPIANO CONTENITORE**  
 Lateral storage shelf - Tablette pour meuble retour  
 Estante para mueble de servicio

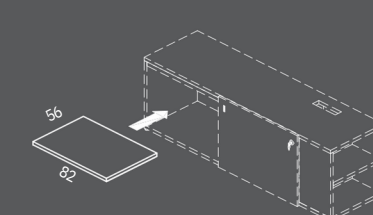

**TOP CONTENITORE P.60**  
 Lateral storage top D. 23 10/16" (H.26) - Top de finition pour meuble retour P.60  
 Top para mueble de servicio P.60

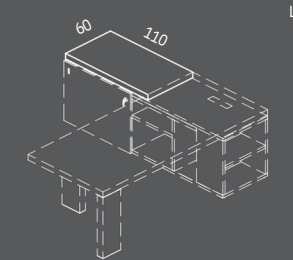

L. 110

**TAVOLI RIUNIONE P.120 (H.73,4)**  
 Conference table D.47 4/16" (H.28 14/16") - Tables de réunion P.120 (H.73,4)  
 Mesas de juntas P.120 (H.73,4)

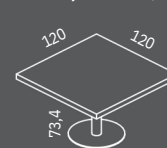

L.120

**TAVOLI RIUNIONE P.120 (H.73,4)**  
 Conference table D.47 4/16" (H.28 14/16") - Tables de réunion P.120 (H.73,4)  
 Mesas de juntas P.120 (H.73,4)

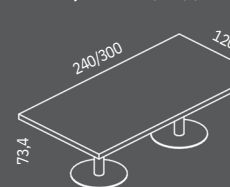

L. 240  
L. 300

**TAVOLI RIUNIONE P.120 (H.73,4)**  
 Conference table D.47 4/16" (H.28 14/16") - Tables de réunion P.120 (H.73,4)  
 Mesas de juntas P.120 (H.73,4)

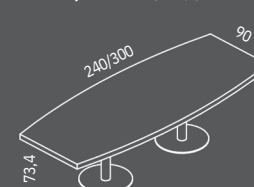

L. 240  
L. 300

**LIBRERIA**  
 Bookcase - Bibliothèque - Librería

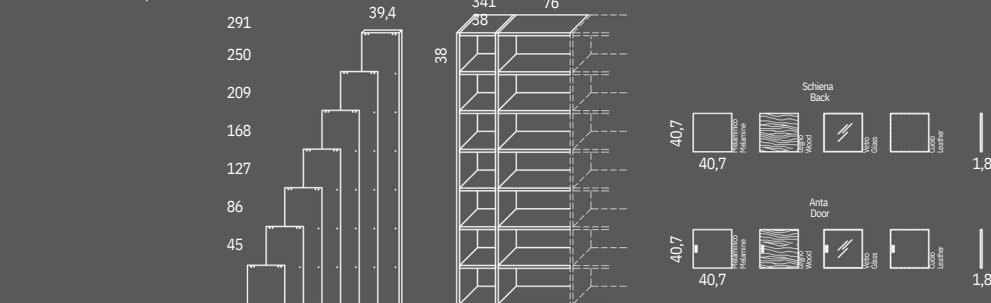

# Finiture | Finishes | Finitions | Acabados

## MEL

### Melaminico

Melamine | Mèlaminé | Melaminico



**Bianco rigato**  
Rippled effect white  
Blanc avec rayures en sérigraphie Blanco rayado



**Grigio rigato**  
Rippled effect grey  
Gris avec rayures en sérigraphie Gris rayado



**Nichel**  
Nickel  
Nickel  
Niquel



**Cacao**  
Cocoa  
Cacao  
Cacao



**Bianco**  
White  
Blanc  
Blanco

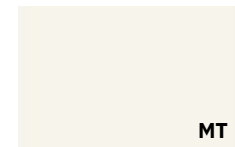

**Talco**  
Talco  
Talco  
Talco



**Ocra**  
Ochre  
Ocre  
Ocre



**Safari**  
Safari  
Safari  
Safari



**Noisette**  
Noisette  
Noisette  
Noisette



**Verde**  
Green  
Vert  
Verde

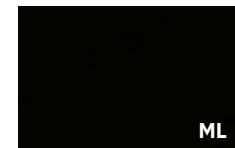

**Nero**  
Black  
Noir  
Negro



**Blu notte**  
Night blue  
Bleu nuit  
Azul noche



**Ardesia**  
Ardesia  
Ardesia  
Pizarra



**Rovere chiaro**  
Light oak  
Chêne clair  
Roble claro



**Rovere americano**  
American oak  
Chêne américain  
Roble americano



**Rovere grigio**  
Grey oak  
Chêne gris  
Roble gris

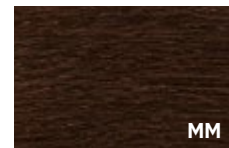

**Rovere moro**  
Dark oak  
Chêne foncé  
Roble oscuro

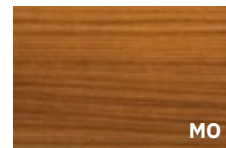

**Noce Canaletto**  
Canaletto Walnut  
Noyer Canaletto  
Nogal Canaletto



**Noce scuro**  
Dark walnut  
Noyer foncé  
Nogal oscuro

MOB

## LGN

### Legno

Wood | Bois | Madera



**Rovere chiaro**  
Light oak  
Chêne clair  
Roble claro



**Rovere grigio fumo**  
Smoke grey oak  
Chêne gris de fumée  
Roble gris humo



**Rovere moro**  
Dark oak  
Chêne foncé  
Roble oscuro



**Noce Canaletto**  
Canaletto Walnut  
Noyer Canaletto  
Nogal Canaletto



**Ebano Silver**  
Silver ebony  
Ebony Silver  
Ebano plata



**Ebano Makassar**  
Makassar ebony  
Ebony Makassar  
Ebano Makassar



**Noce termocotto**  
Heat-treated walnut  
Noyer thermo traité  
Nogal termotratado

MOD TOP

## CUO

### Cuoio

Leather | Cuir | Cuero

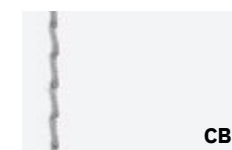

**Bianco**  
White  
Blanc  
Blanco



**Alluminio**  
Aluminium  
Aluminium  
Aluminio



**Nero**  
Black  
Noir  
Negro



**Testa di moro**  
Brown  
Tete de maure  
Marron oscuro



**Caramello**  
Caramel  
Caramel  
Caramelo

TOP



**Arancione**  
Orange  
Orange  
Naranja

- Le finiture contenute nel presente catalogo sono puramente indicative e non sono di riferimento per le forniture del prodotto.
- Due to the printing process, finishes shown in this catalogue are for illustration only. The finish on the final item may differ slightly from the printed illustration.
- Les finitions contenues dans ce catalogue ne sont pas contractuelles - les photos ne pouvant rendre la parfaite réalité.
- Los acabados contenidos en este catálogo son puramente indicativos y no son de referencia para los suministros del producto.

- Le finiture contenute nel presente catalogo sono puramente indicative e non sono di riferimento per le forniture del prodotto.
- Due to the printing process, finishes shown in this catalogue are for illustration only. The finish on the final item may differ slightly from the printed illustration.
- Les finitions contenues dans ce catalogue ne sont pas contractuelles - les photos ne pouvant rendre la parfaite réalité.
- Los acabados contenidos en este catálogo son puramente indicativos y no son de referencia para los suministros del producto.

## GOF

### Metacrilato retrolaccato

Backpainted acrylic | Méthacrylate rétro-laqué | Metacrilato retrolacado

MOB



**Bianco**  
White  
Blanc  
Blanco



**Argento**  
Silver  
Argent  
Plata



**Grigio scuro**  
Dark grey  
Gris foncé  
Gris oscuro



**Noisette**  
Noisette  
Noisette  
Noisette



**Ardesia**  
Ardesia  
Ardesia  
Pizarra

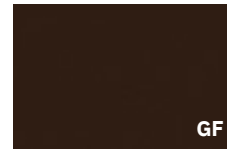

**Moka**  
Mocha  
Moka  
Cafe



**Nero**  
Black  
Noir  
Negro



**Arancione**  
Orange  
Orange  
Naranja



**Rosso "F"**  
Red "F"  
Rouge "F"  
Rojo "F"



**Rubino**  
Ruby  
Rubis  
Rubi



**Indaco**  
Indigo  
Indigo  
Azul Indigo



**Azzurro**  
Blue  
Bleu  
Azul



**Verde**  
Green  
Vert  
Verde



**Cedro**  
Lime green  
Vert Cédrat  
Verde Cedro

## MTC

### Metacrilato

Acrylic | Méthacrylate | Metacrilato

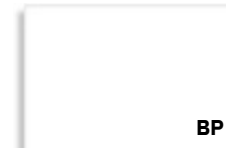

**Bianco opalino**  
Opaline white  
Blanc opalin  
Blanco opaco

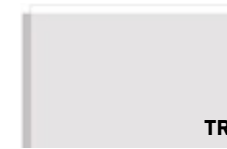

**Trasparente**  
Transparent  
Transparent  
Transparente



**Rosso trasparente**  
Red transparent  
Rouge transparent  
Rojo transparente



**Blu trasparente**  
Blue transparent  
Bleu transparent  
Azul transparente



**Bianco satinato**  
Satin-finish white  
Blanc satiné  
Blanco satinado

BT



**Grigio fumè satinato**  
Satin-finish smoky grey  
Gris satiné  
Gris satinado



**Arancione satinato**  
Satin-finish orange  
Orange satiné  
Naranja satinado



**Blu satinato**  
Satin-finish  
blue Bleu satiné  
Azul satinado



**Verde satinato**  
Satin-finish  
green Vert satiné  
Verde satinado

- Le finiture contenute nel presente catalogo sono puramente indicative e non sono di riferimento per le forniture del prodotto.
- Due to the printing process, finishes shown in this catalogue are for illustration only. The finish on the final item may differ slightly from the printed illustration.
- Les finitions contenues dans ce catalogue ne sont pas contractuelles - les photos ne pouvant rendre la parfaite réalité.
- Los acabados contenidos en este catálogo son puramente indicativos y no son de referencia para los suministros del producto.

- Le finiture contenute nel presente catalogo sono puramente indicative e non sono di riferimento per le forniture del prodotto.
- Due to the printing process, finishes shown in this catalogue are for illustration only. The finish on the final item may differ slightly from the printed illustration.
- Les finitions contenues dans ce catalogue ne sont pas contractuelles - les photos ne pouvant rendre la parfaite réalité.
- Los acabados contenidos en este catálogo son puramente indicativos y no son de referencia para los suministros del producto.

**EPX**  
**Epossidico**  
Epoxy | Epoxy | Epoxi



<b>Bianco</b> White Blanc Blanco	<b>EB</b>	<b>Talco</b> Talco Talco Talco	<b>ET</b>	<b>Grigio</b> Grey Gris Gris	<b>EG</b>	<b>Beige Arizona</b> Arizona beige Beige Arizona Beige Arizona	<b>YD</b>	<b>Noisette</b> Noisette Noisette Noisette	<b>EO</b>
<b>Safari</b> Safari Safari Safari	<b>EK</b>	<b>Rame</b> Copper Cuivre Cobre	<b>EE</b>	<b>Rosso Jaipur</b> Jaipur red Rouge Jaipur Rojo Jaipur	<b>YB</b>	<b>Bronzo</b> Bronze Bronze Bronce	<b>EZ</b>	<b>Blu notte</b> Night blue Bleu nuit Azul noche	<b>YQ</b>
<b>Grigio Bromo</b> Bromo grey Gris Bromo Gris Bromo	<b>YC</b>	<b>Ardesia</b> Ardesia Ardesia Pizarra	<b>EI</b>	<b>Verde Comodoro</b> Comodoro green Vert Comodoro Verde Comodoro	<b>YV</b>	<b>Nero</b> Black Noir Negro	<b>EN</b>		

# aura design



Hub Spaces, 582 Honeypot Lane, Stanmore, HA7 1JS, UK  
[www.auraadesign.co.uk](http://www.auraadesign.co.uk)  
020 3915 8008  
[info@auraadesign.co.uk](mailto:info@auraadesign.co.uk)

