

CARITA

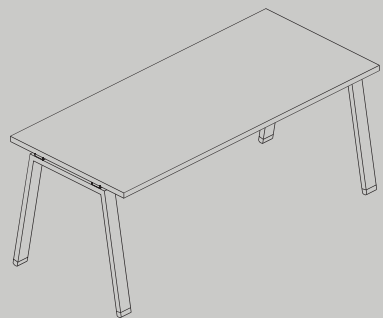

operativi | workstations | systèmes | operativos

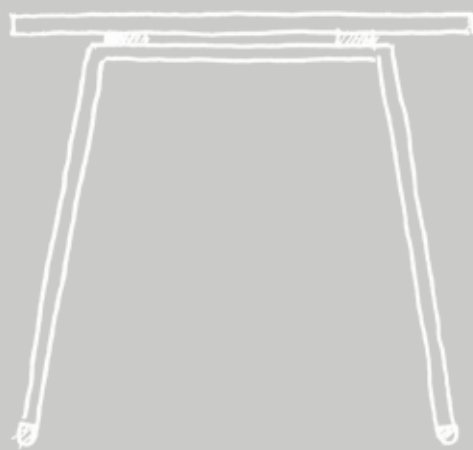

Forme e colori

che donano all'ambiente di lavoro un senso di freschezza e creatività.

Carita collection with its versatile shapes and colours, delivers freshness and creativity to your work environment.

La collection Carita avec ses formes et couleurs donne un sentiment de créativité à l'environnement.

La colección Carita, con sus distintas formas y colores, nos entrega frescura y creatividad al medio ambiente.

Carita 5

/versatility Carita is a versatile system that offers ideal solutions for single or multiple workstations. Structural side storage units can be equipped with a cushion. Legs are available in various shapes, open or loop legs.

/versatilité Carita est un système très polyvalent qui offre des solutions idéales pour un ou plusieurs postes de travail. Les conteneurs latéraux structurels peuvent être équipés d'un coussin. Les pieds ont des formes variées, ouvertes ou en anneau.

/versatilitad Carita es un sistema muy versátil que ofrece soluciones ideales para estaciones de trabajo individuales o múltiples. Los contenedores laterales estructurales se pueden equipar con un cojín. Las patas tienen varias formas, abiertas o en anillo.

/versatilità

Carita è un sistema molto versatile che offre soluzioni ideali per le postazioni di lavoro singole o multiple. I contenitori laterali strutturali possono essere dotati di cuscino. Le gambe hanno varie forme, aperte o ad anello.



/funzionalità

I bench con contenitori strutturali laterali sono una soluzione molto funzionale. Infatti, consentono di compattare lo spazio di archiviazione in prossimità della postazione di lavoro, mentre il transito dei cavi avviene all'interno del vano tecnico (schiena removibile).



Carita 5



/functionality benches with lateral structural storage units are an excellent functional solution. In fact, they allow to compact the storage space, keeping it close to the workstation. Structural units are equipped with a false back to allow cable management.



/fonctionnalité les bench avec des conteneurs structuraux latéraux sont une solution très fonctionnelle. En effet, ils permettent de compacter l'espace de stockage à proximité du poste de travail, tandis que le passage des câbles s'effectue à l'intérieur du compartiment technique (dos amovible).



/funcionalidad los bench con contenedores estructurales laterales son una solución muy funcional. De hecho, permiten compactar el espacio de almacenamiento cerca de la estación de trabajo, mientras que el tránsito de los cables se realiza dentro del compartimiento técnico (parte posterior extraíble).

Carita 5





/tutto a portata di mano

I contenitori strutturali sono perfetti per diverse soluzioni dal grande impatto estetico. Si possono accessorizzare con cuscini rivestiti in tessuto che conferiscono una nuova funzione di seduta.

/everything at your fingertips structural storage units are perfect for a variety of aesthetically pleasing solutions. They can be accessorized with cushions upholstered in fabric that give them a new function.

/tout à portée de main les meubles de service sont parfaits pour les différentes solutions d'un grand impact esthétique. Ils peuvent être accessorisés avec coussins en tissu qui donnent une nouvelle fonction d'assise.

/todo a mano los contenedores estructurales son perfectos para diferentes soluciones de gran impacto estético. Se pueden equipar con cojines revestidos en tela que confieren una nueva función.





Carita 9

Carita 9

/paneles de separación los bench con sobre de una sola pieza de gran tamaño están diseñados para ser equipados con paneles de separación colocados arriba del sobre mismo. Los paneles de separación pueden ocupar todo el ancho disponible o quedarse remetidos. Las esquinas pueden ser redondeadas de acuerdo con las elecciones estéticas.

/écrans de séparation les bench avec un plateau d'un seul tenant sont conçus pour être accessorisés avec des écrans de séparation qui se fixent directement au-dessus du plateau. Ils peuvent recouvrir toute la longueur du plateau ou être rentrants. Les coins peuvent être arrondis selon choix esthétique.

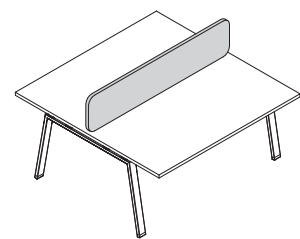
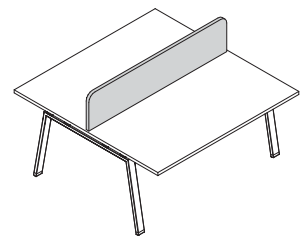
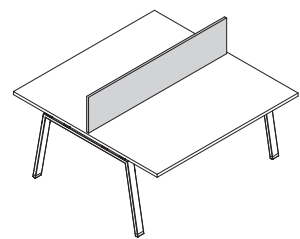

/screen

I bench con piano unico di ampie dimensioni sono pensati per essere accessoriati con screen soprapiano. Questi ultimi possono occupare tutta la larghezza del piano oppure essere rientranti. Gli angoli possono essere raggiati in base alle scelte estetiche.

/screens large single bench tops are designed to be accessorized with screens above the worktop. They can fulfil the entire width or be recessed. Corners can be rounded, depending on the aesthetic choices.



Carita 6

Ai bench con piani separati ed alle scrivanie singole, si possono agganciare screen rettangolari o trapezoidali oltre alla particolare forma "a onda".

Rectangular or trapezoidal screens (as well as the special "wave" shape) can be hung to benches with separate tops or to single desks.

Aux bench avec plateaux séparés et aux bureaux individuels, on peut accrocher des écrans de séparation rectangulaires ou trapézoïdaux en ajoute à la particulière forme en "vague".

Los bench con sobres sueltos y las mesas, se pueden equipar con paneles de separación rectangulares o trapezoidales, además de la particular forma "onda".





Carita 8



Carita 1

/regolazione

Le gambe Carita sono disponibili in diversi colori epossidici e possono essere posizionate a filo con il piano oppure rientranti. Tutte le versioni di gamba presentano anche una soluzione regolabile in altezza cm 65- 85 (altezza sopra-piano).

***/adjustment** Carita legs come in several epoxy paint finishes and can be flush with the top or recessed. All leg options feature a 65-85 cm height-adjustable version (25 9/16"-33 7/16") (height above the top).*



***/réglage** les pieds Carita sont disponibles dans différentes couleurs époxy et peuvent être placées à ras du plan de travail ou en retrait. Toutes les versions de jambe disposent également d'une solution réglable en hauteur de 65 à 85 cm (hauteur au-dessus du plateau).*

***/ajuste** las patas de Carita están disponibles en diferentes colores epoxi y se pueden quedar alineadas con el sobre o remetidas. Todas las versiones de patas tienen también una solución ajustable en altura cm 65-85 (altura sobre el tablero).*





Carita 5



A

/convenience To support Carita rectangular benches and manage electrification down to the floor, central melamine bases can be used. It is possible to choose between the 43x37 cm version with removable panel (A) and the "slim" 30x30 cm version with hinged door (B).

/commodité afin de supporter les bench rectangulaire Carita et gérer l'électrification jusqu'au sol, il y a la possibilité d'utiliser des bases centrales en mélaminé. La choix tombe sur la version 43x37 cm avec panneaux amovible (A) et sur la version "slim" 30x30 cm avec porte battente (B).

/practicidad para soportar los bench rectangulares Carita y para gestionar la electrificación hasta el suelo, se pueden utilizar las bases centrales de melamina. Es posible elegir entre la versión de 43x37 cm con panel removable (A) y la versión "slim" de 30x30 cm con puerta batiente (B).

/praticità

Per supportare i bench rettangolari Carita e gestire l'elettrificazione fino a terra, si possono utilizzare i basamenti centrali in melaminico. È possibile scegliere tra la versione 43x37 cm con pannello asportabile (A) e la versione "slim" 30x30 cm con anta battente (B).



B

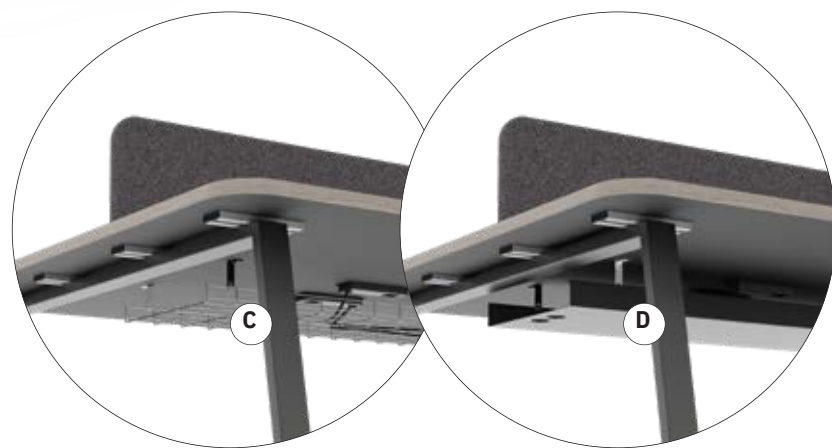

C

D

I cavi sotto il piano di lavoro vengono raccolti da cestelli (C) o canale in metallo verniciato epossidico (D).

Cables under the worktop are collected by baskets (C) or epoxy painted metal trays (D).

Les câbles au-dessous du plateau sont rassemblés dans paniers passe-câbles en fil d'acier (C) ou outotte en métal vernie époxy (D).

Los cables bajo la superficie de trabajo son recogidos en cestas en rejilla de acero (C) o vigas en metal pintado epoxi (D).

Carita 5



Carita 5



/condivisione

Le postazioni allineate ed i bench sfruttano la possibilità delle gambe Carita di essere condivise, riducendo al minimo i componenti strutturali. Le gambe centrali possono essere a filo con il piano oppure rientranti.

/sharing in line workstations and benches take advantage of the possibility of Carita legs being shared, reducing structural components. The central legs can be either flush with the top or recessed.

/partage les postes de travail côte-à-côte et les bench ont la possibilité de partager les pieds Carita, en réduisant au minimum les composants structurels. Les pieds intermédiaires peuvent être alignés ou rentrants par rapport au plateau.



/compartición las estaciones de trabajo alineadas y los bench aprovechan de la posibilidad de las patas Carita de ser compartidas, reduciendo al mínimo los componentes estructurales. Las patas centrales se pueden quedar alineadas con el sobre o remetidas.

Carita 9





***/combinaisons** parmi les solutions de stockage les plus récentes, nous trouvons Lato, la collection d'armoires modulaires avec coque en mélamine. Les portes peuvent être en mélamine ou en métal, tandis que le dos en mélamine peut être recouvert de tissu. Les nombreuses options de matériaux et de couleurs font du Lato le complément idéal des bureaux Carita.*

***/combinaciones** entre las soluciones de almacenamiento más actuales, encontramos Lato, la colección de gabinetes modulares con carcasa de melamina. Las puertas pueden ser de melamina o metal, mientras que las traseras de melamina pueden cubrirse con tela. Las numerosas opciones de materiales y colores hacen de Lato el complemento ideal para los escritorios Carita.*

/accostamenti

Tra le soluzioni più attuali di archiviazione troviamo Lato, la collezione di armadietti modulari con scocca in melaminico. Le ante possono essere in melaminico o metallo, mentre le schiene in melaminico possono essere rivestite in tessuto. Le molte opzioni di materiali e colori, rendono Lato il complemento ideale per le scrivanie Carita.

***/combinations** our most trendy storage solutions include Lato, the modular locker system with melamine shell. Doors are available in melamine or metal, whilst melamine back panels can be upholstered in fabric. The various materials and finish options make Lato an ideal complement to Carita desks.*





Carita 5



***/aesthetics** ring legs are a simple and elegant aesthetic choice that suits both bench solutions and individual desks. All leg types are equipped with ergonomic feet and millimetric levelling screws in translucent black or white polypropylene.*

***/esthétique** les pieds fermés sont une choix esthétique simple et élégant disponibles soit pour solutions bench soit pour bureaux individuels. Toutes typologies de pieds sont équipé de vérin ergonomiques et vis de nivelage en polypropylène translucide noir ou blanc.*

***/estética** las patas de anillo son una opción estética simple y elegante que se adapta tanto a estaciones de trabajo así como a mesas individuales. Todos los modelos de patas están equipados de pies ergonómicos y tornillos de nivelación milimétricos en polipropileno blanco o negro translúcido.*

/estetica

Le gambe ad anello sono una scelta estetica semplice ed elegante che si addice sia a soluzioni bench che alle scrivanie singole. Tutte le tipologie di gambe sono dotate di piedini ergonomici e viti di livellamento millimetriche in polipropilene traslucido nero o bianco.





Carita 4





Carita 8

Carita 8

Le postazioni a 120° sono ideali per compattare i posti lavoro in modo creativo e funzionale. Anche per questi gruppi da tre, il basamento triangolare centrale è dotato di sportello per accesso al cablaggio.

/postazioni multiple



***/clusters** 120° compositions are ideal for compacting workplaces in a creative and functional way. For three-workstation clusters, the central triangular base features a door for wiring access.*



***/postes de travail multiples** les postes de travail à 120° sont idéaux pour le compactage des lieux de travail de manière créative et fonctionnelle. Pour ces groupes de trois, la base triangulaire centrale est équipée d'une porte permettant d'accéder au câblage.*

***/estaciones múltiples de trabajo** las estaciones 120° son ideales para compactar puestos de trabajo de una manera creativa y funcional. También para estos grupos de tres, la base triangular central está equipada con una puerta para acceder al cableado.*



Carita 8





Carita

/direzionali

La straordinaria flessibilità della collezione Carita permette di soddisfare anche le esigenze di un ufficio privato. La scrivania può infatti essere interpretata per soluzioni direzionali, moderne ed eleganti.

*l*executive the extraordinary flexibility of the Carita collection means that it can also meet the need of private offices. Desks can be interpreted for executive, modern and elegant solutions.

*l*exécutif l'extraordinaire flexibilité de la collection Carita, permet de satisfaire également les exigences d'un bureau privé. Le bureau peut être conçu pour solutions exécutives, modernes et élégantes.

*l*despachos ejecutivos la extraordinaria flexibilidad de la colección Carita permite satisfacer también las necesidades de un despacho privado. La mesa, de hecho, puede ser interpretada para soluciones ejecutivas, modernas y elegantes.



/accessori

Offriamo molteplici soluzioni per accessoriare i piani di scrivanie, bench e tavoli. L'elettificazione può essere gestita in modo semplice e pratico grazie ai moduli Flat, che permettono di integrare direttamente al piano un sistema di prese personalizzabile. La cornice in metallo verniciato si abbina perfettamente al colore della struttura, enfatizzando un design che pensa ad ogni minimo dettaglio.

***/accessories** we offer a wide range of solutions to equip desks, benches and tables. Electrification can be managed in a simple and practical way thanks to Flat modules, which allow a customisable socket system to be integrated directly into the top. The painted metal frame perfectly matches the colour of the structure, emphasising a design that pays attention to every detail.*

Carita

***/accessoires** beaucoup de solutions sont offertes afin de pouvoir accessoriser les plateaux de bureaux, bench et tables de réunion. L'électrification peut être gérée très simplement grâce à nos modules Flat, qui permettent d'incorporer le système de prises directement sur le plateau. Le cadre en métal époxy est parfaitement coordonné à la couleur de la structure, en mettant en valeur un design qui pense à chaque petit détail.*

***/accesorios** ofrecemos muchas soluciones para electrificar lo sobres de mesas, estaciones de trabajo y mesas de juntas. La electrificación se puede manejar de manera simple y práctica gracias a los módulos Flat, que permiten integrar directamente en el sobre un sistema de tomas personalizables. El marco de metal pintado se combina perfectamente con el color de la estructura, enfatizando un diseño que piensa en cada mínimo detalle.*



Carita 2



/riunioni

I tavoli riunione Carita possono essere singoli o multipli. In entrambi i casi vengono proposti sia con gamba a cavalletto che con gamba a ponte. Le linee essenziali permettono di giocare sugli abbinamenti tra piano e gamba per rendere l'arredo unico ed accogliente.

Meetings Carita meeting tables can be single or multiple. In both cases they are available with either A-shape or straight legs. The essential lines allow you to play with top and leg combinations to make furniture unique and welcoming.

Carita 2

***Iréunion** les tables de réunion Carita peuvent être individuelles ou multiples. Dans les deux cas, elles sont proposées avec pieds trapèze ainsi que pieds droits. Les lignes essentielles permettent de jouer sur les compléments entre plateau et pied, afin de créer l'aménagement unique et accueillant.*

***Ireuniones** las mesas de reunión Carita pueden ser individuales o múltiples. En ambos casos se proponen tanto con pata de caballete como con pata recta. Las líneas esenciales permiten jugar en las combinaciones entre sobre y pata para hacer el mobiliario único y acogedor.*



Carita 10





Carita 10

/media consoles Carita consoles are available in both mobile and fixed versions and offer space to hung monitors. Cables are collected inside the vertical panel and exit through a special access.

/cloisons techniques Les cloisons techniques Carita peuvent être fixés au mur ou avoir des roulettes afin de pouvoir être déplacés. Ils offrent également un espace pour accrocher un moniteur. Les câbles sont cachés dans le cloison vertical et ils sortent par un accès approprié.

/media console las consolas Carita son disponibles tanto en la versión móvil que fija y ofrecen espacio para colocar los monitores. Los cables se recogen en el interior del panel vertical y salen de un especial acceso.

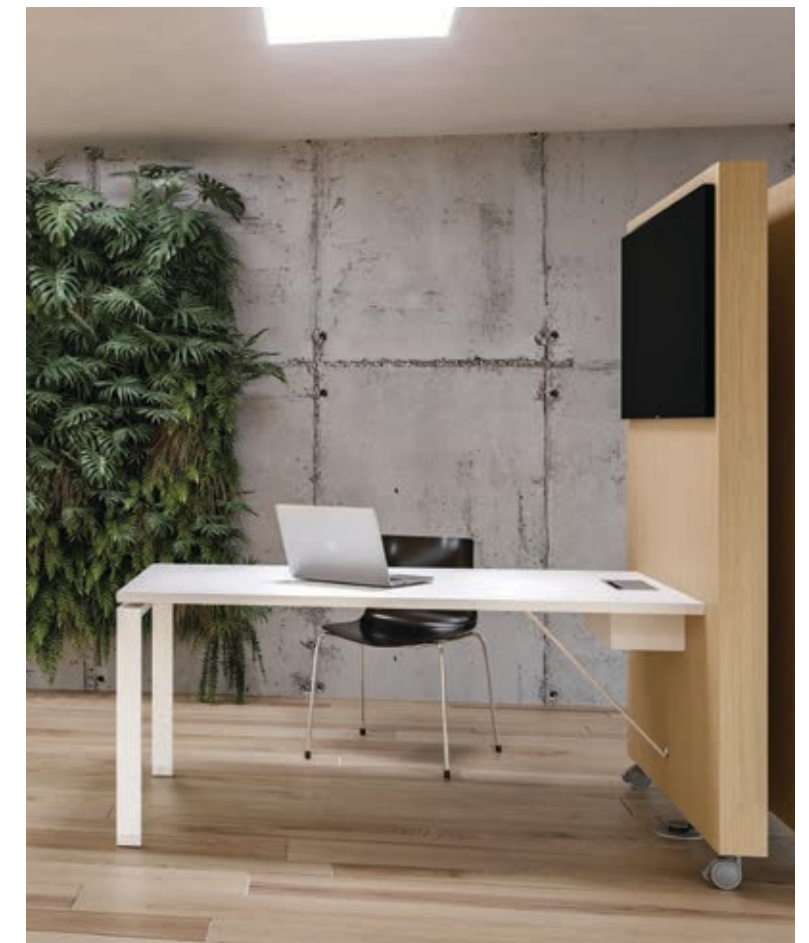

/media console

Le console Carita sono disponibili sia nella versione mobile che fissa e offrono spazio per agganciare i monitor. I cavi sono raccolti all'interno del pannello verticale e fuoriescono da un apposito accesso.

Piani | desk tops | plateaux | sobres

con angoli dritti, in melaminico
with straight corners, Italian melamine avec coins droits, en mélaminé con esquinas rectas, en melaminico

con angoli raggiati, in melaminico
with rounded corners, Italian melamine avec coins arrondis, en mélaminé con esquinas redondeadas, en melaminico

gli screen sono possono essere sia fissi che mobili, disponibili nelle finiture: melaminico, goffrato, metacrilato, tessuto, OSB
screens can be fixed or mobile, available in the following finishes: Italian melamine, embossed, acrylic, fabric, OSB
les écrans peuvent être fixes ou mobiles, disponibles dans les finitions: mélaminé, gaufré, méthacrylate, tissu, OSB
los paneles pueden ser fijos o móviles, disponibles en los siguientes acabados: melaminico, lacado, metacrilato, tejido, OSB

Gambe | legs | pieds | patas

a cavalletto, in metallo anche con inserto legno
A-shape, metal epoxy painted, also with solid wood insert
tréteau, métal peint époxy, aussi avec insert en bois
caballete, metal pintado epoxi, también con inserto de madera

a ponte, metallo verniciato epossidico
straight, metal epoxy painted
droit, métal peint époxy
recta, metal pintado epoxi

ad anello, metallo verniciato epossidico
closed loop, metal epoxy painted
en anneau, métal peint époxy
anillo, metal pintado epoxi

Scrivanie | desks | bureaux | mesas

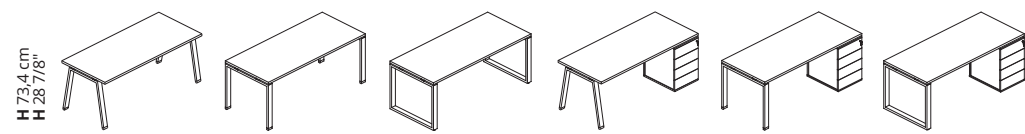

L 120/140/160/180/200 - P 80/90 cm
W 47 1/4"/55 1/8"/63"/70 7/8"/78 3/4" - D 31 1/2"/35 3/8"

Dattilo | returns | retours | alas

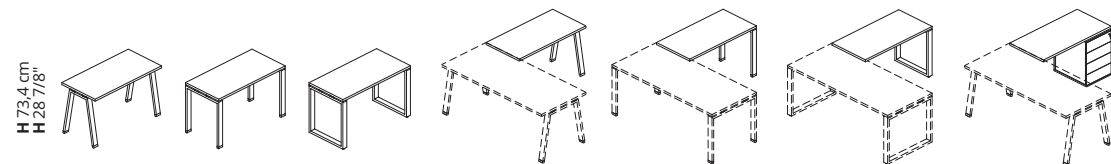

L 80/100/120 - P 60 cm
W 31 1/2"/39 3/8"/47 1/4" - D 23 5/8"

Tavoli riunione | meeting tables | tables de réunion | mesas de juntas

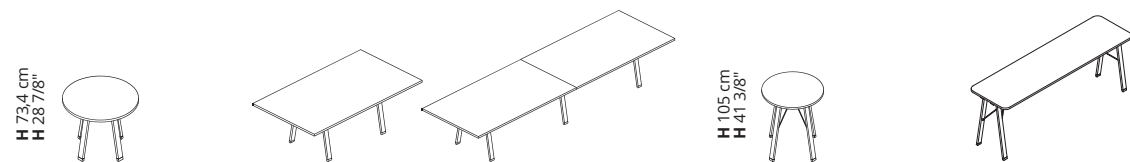

Ø 90/100/120/130/150 cm Ø 35 3/8"/39 cm W 82 5/8"/110 3/8"/47 1/4"/51 1/8"/59" L 210/280 - P 120 cm W 165 3/8"/220 1/2" - D 47 1/4" L 420/560 - P 120 cm W 165 3/8"/220 1/2" - D 47 1/4" Ø 90/100/120/130/150 cm Ø 35 3/8"/39 cm W 55 1/8"/63"/70 7/8"/78 3/4"/86 5/8"/94 1/2"/102 3/8"/110 1/4" - D 23 5/8"/31 1/2"

Tavolini da caffè | coffee tables | tables basses | mesitas

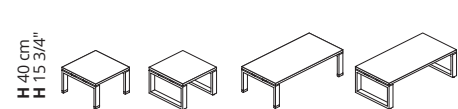

L/P 60 cm W/D 23 5/8" L 120 - P 60 cm W 47 1/4" - D 23 5/8"

Mobili di servizio | service units | meuble retour | muebles de servicio

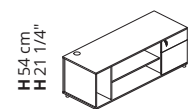

L 160 - P 58 cm W 63" - D 22 7/8"

Esempi composizioni | composition example | exemples de compositions | ejemplos de composiciones

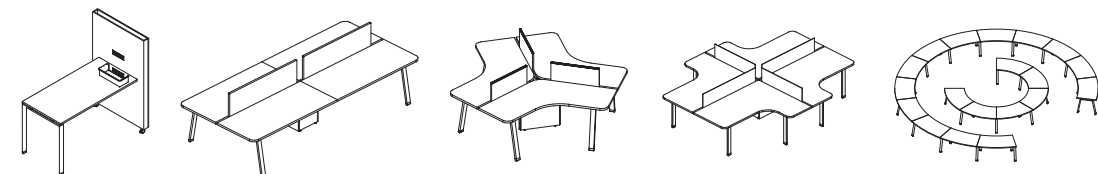











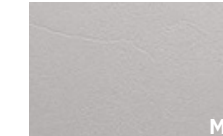
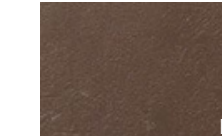

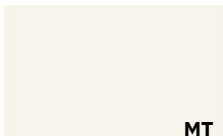

Finiture | Finishes | Finitions | Acabados

TOP MOB MOD SCR

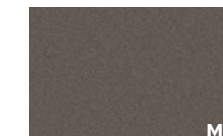
MEL

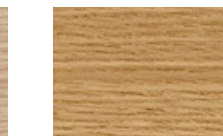
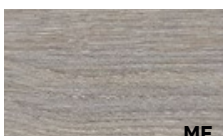
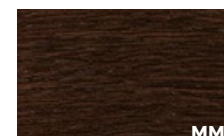
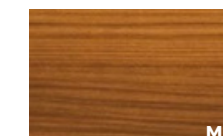
Melaminico
Melamine | Mélaminé | Melaminico

 Bianco rigato Rippled effect white Blanc avec rayures en sérigraphie Blanco rayado	 Grigio rigato Rippled effect grey Gris avec rayures en sérigraphie Gris rayado	 Nichel Nickel Nickel Niquel	 Cacao Cocoa Cacao Cacao	 Bianco White Blanc Blanco
 Talco Talco Talco Talco	 Ocra Ochre Ocre Ocre	 Safari Safari Safari Safari	 Noisette Noisette Noisette Noisette	 Verde Green Vert Verde
 Nero Black Noir Negro	 Blu notte Night blue Bleu nuit Azul noche	 Ardesia Ardesia Ardesia Pizarra	 Rovere chiaro Light oak Chêne clair Roble claro	 Rovere americano American oak Chêne américain Roble americano
 Rovere grigio Grey oak Chêne gris Roble gris	 Rovere moro Dark oak Chêne foncé Roble oscuro	 Noce Canaletto Canaletto Walnut Noyer Canaletto Nogal Canaletto	 Noce scuro Dark walnut Noyer foncé Nogal oscuro	

OSB

OSB
OSB | OSB | OSB



OSB
OSB
OSB
OSB

SCR

Le finiture contenute nel presente catalogo sono puramente indicative e non sono di riferimento per le finiture del prodotto Due to the printing process, finishes shown in this catalogue are for illustration only. The finish on the final item may differ slightly from the printed illustration
Les finitions contenues dans ce catalogue ne sont pas contractuelles - les photos ne pouvant rendre la parfaite réalité
Los acabados contenidos en este catálogo son puramente indicativos y no son de referencia para los suministros del producto

TES

Tessuto

Fabric | Tissu | Tejido



Beige
Beige
Beige
Beige



Grigio chiaro
Light grey
Gris clair
Gris claro



Ardesia
Ardesia
Ardesia
Pizarra



Blu avio
Avio blue
Bleu avio
Azul avio



Acquamarina
Aquamarine
Aigue-marine
Aguamarina



Verde primavera
Spring green
Vert printemps
Verde primavera



Salvia
Sage
Sauge
Salvia



Arancio
Orange
Orange
Naranja



Corallo
Coral
Corail
Coral

SCR

MTC

Metacrilato

Acrylic | Méthacrylate | Metacrilato

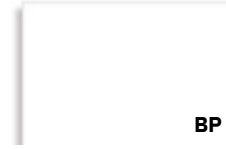

Bianco opalino
Opaline white
Blanc opalin
Blanco opaco



Trasparente
Transparent
Transparent
Transparente



Rosso trasparente
Red transparent
Rouge transparent
Rojo transparente



Blu trasparente
Blue transparent
Bleu transparent
Azul transparente

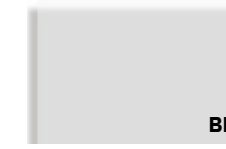

Bianco satinato
Satin-finish white
Blanc satiné
Blanco satinado



Grigio fumè satinato
Satin-finish smoky grey
Gris satiné
Gris satinado



Arancione satinato
Satin-finish orange
Orange satiné
Naranja satinado



Blu satinato
Satin-finish
blue Bleu satiné
Azul satinado



Verde satinato
Satin-finish
green Vert satiné
Verde satinado

SCR

GOF

Goffrato

Embossed | Gaufré | Gofrado



Bianco
White
Blanc
Blanco



Argento
Silver
Argent
Plata



Grigio scuro
Dark grey
Gris foncé
Gris oscuro



Noisette
Noisette
Noisette
Noisette



Ardesia
Ardesia
Ardesia
Pizarra



Moka
Mocha
Moka
Cafe



Nero
Black
Noir
Negro



Arancione
Orange
Orange
Naranja



Rosso "F"
Red "F"
Rouge "F"
Rojo "F"



Rubino
Ruby
Rubis
Rubi



Indaco
Indigo
Indigo
Azul Indigo



Azzurro
Blue
Bleu
Azul



Verde
Green
Vert
Verde



Cedro
Lime green
Vert Cédrot
Verde Cedro

SCR

EPX

Epossidico

Epoxy | Époxy | Epoxi



Bianco
White
Blanc
Blanco



Talco
Talco
Talco
Talco



Grigio
Grey
Gris
Gris



Beige Arizona
Arizona beige
Beige Arizona
Beige Arizona



Noisette
Noisette
Noisette
Noisette



Safari
Safari
Safari
Safari

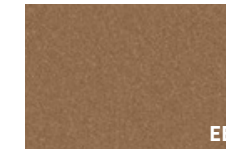

Rame
Copper
Cuivre
Cobre



Rosso Jaipur
Jaipur red
Rouge Jaipur
Rojo Jaipur

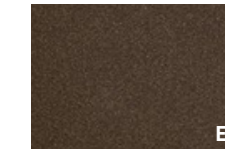

Bronzo
Bronze
Bronze
Bronze



Blu notte
Night blue
Bleu nuit
Azul noche



Grigio Bromo
Bromo grey
Gris Bromo
Gris Bromo

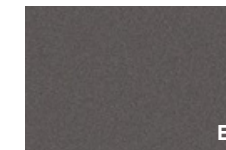

Ardesia
Ardesia
Ardesia
Pizarra



Verde Comodoro
Comodoro green
Vert Comodoro
Verde Comodoro



Nero
Black
Noir
Negro

STRU

Applicazioni finiture

Finish application | Application finitions | Aplicacion acabados



TOP
Top
Plano
Plateau
Sobre



SCR
Screen
Screen
Écran
Panel



MOD
Modesty panel
Modesty panel
Voile de fond
Faldón



MOB
Mobile di servizio
Service unit
Meuble de service
Mueble de servicio



STRU
Struttura
Structure
Structure
Structura

Le finiture contenute nella stampa sono puramente indicative e non sono di riferimento per le forniture del prodotto

Due to the printing process, finishes shown in this document are for illustration only. The finish on the final item may differ slightly from the printed illustration.
Les finitions contenues dans l'impression sont purement indicatives et ne sont pas pertinentes pour les fournitures du produit.
Los acabados contenidos en la impresión son puramente indicativos y no son de referencia para los suministros del producto.

ecologia

Auraa Design utilizza per i suoi prodotti e i suoi imballi materiali facilmente separabili e riciclabili.

attestazione di prodotto

I prodotti **Auraa Design** sono stati sottoposti a prove prestazionali presso laboratori di prova accreditati. Copia dei rapporti di prova o delle attestazioni di conformità sono disponibili su richiesta. I prodotti Auraa Design soddisfano i requisiti LEED per il credito IEQ4.5 per i materiali a bassa emissione ed i requisiti ANSI/BIFMA X7.1-2011. Auraa Design dichiara di utilizzare pannelli a base di legno aventi un rilascio di formaldeide conforme alla classe E1 secondo il DM 10/10/2008. Auraa Design si impegna inoltre ad utilizzare materiali legnosi FSC e pannelli a base di legno con certificazione CARB2.

environment

Auraa Design products and packaging are made of recyclable materials.

product certification

Auraa Design products have been subjected to performance tests at accredited testing laboratories. Copies of test reports or certificates of conformity are available on request. Auraa Design products meet the LEED requirements for IEQ4.5 credit for low emission materials and the ANSI/BIFMA X7.1-2011 requirements. Auraa Design declares to use wood-based panels with a formaldehyde release according to class E1 according to DM 10/10/2008. Auraa Design also undertakes to use FSC wood-based materials and CARB2-certified wood-based panels.

environnement

Auraa Design utilise des matériaux facilement séparables et recyclables pour ses produits et ses emballages.

certification de produits

Les produits **Auraa Design** ont été soumis à des tests de performance dans des laboratoires accrédités. Des copies des rapports d'essais ou des certificats de conformité sont disponibles sur demande. Les produits Auraa Design répondent aux exigences LEED pour le crédit IEQ4.5 pour les matériaux à faibles émissions et aux exigences ANSI/BIFMA X7.1-2011. Auraa Design déclare utiliser des panneaux à base de bois avec un dégagement de formaldéhyde selon la classe E1 selon DM 10/10/2008. Auraa Design s'engage également à utiliser des matériaux à base de bois FSC et des panneaux à base de bois certifiés CARB2.

ecología

Auraa Design utiliza productos y embalajes en materiales fácilmente separables y reciclables.

certificación de producto

Los productos **Auraa Design** han sido sometidos a pruebas de rendimiento en laboratorios de pruebas acreditados. Copias de los informes de las pruebas o certificados de conformidad están disponibles bajo petición. Los productos Auraa Design cumplen con los requisitos LEED para el crédito IEQ4.5 para materiales de baja emisión y los requisitos ANSI/BIFMA X7.1-2011. Auraa Design declara utilizar paneles de madera con una emisión de formaldehído según la clase E1 según DM 10/10/2008. Auraa Design también se compromete a utilizar materiales a base de madera FSC y paneles a base de madera certificados por CARB2.

design

Mirto Antonel & Filippon

art direction

Mirto Antonel

AC/CACB/AD

aura design



Hub Spaces, 582 Honeypot Lane, Stanmore, HA7 1JS, UK
www.auraadesign.co.uk
020 3915 8008
info@auraadesign.co.uk