

aura  
design

Cardon

---



## Pedestals with shutters



# Pedestals with shutters

## STRUCTURE

- Chipboard coated on both sides with melamine resin with increased durability - 1st class.
- Chipboard with reduced formaldehyde emission, E1 standard.
- Side edges finished with 2 mm thick ABS plastic edge with 3 mm radius.
- Carcass and floor are made of 18 mm thick chipboard.
- Top made of 25 mm thick board as standard.
- Top made of 18 mm thick board as an option - pedestal 7 mm lower.
- 8 mm thick board back wall as standard, 18 mm thick board as an option with a surcharge.
- Right-sided tambour door available in black or aluminum color.



## ADDITIONAL EQUIPMENT

- White board inside drawer with full extension slide - RK 96.
- 25 or 18 mm thick top (to be specified when ordering) on plinths H: 60 mm, powder-coated or chromium-plated.

## HEIGHT

- Pedestal height with no add-on top: 1090 mm (with add-on top +60 mm).
- Pedestals with tambour doors are equipped with castors 75 mm in diameter, front castors equipped with brakes.

## EQUIPMENT

- B1 handles as standard. A1, C1 or side slat as an option with no surcharge. Z1 or V1 handles as an option with a surcharge.
- Pedestals are equipped with a lock with a removable cylinder with two numbered keys.
- Possibility to choose identical lock as in the cabinets of your choice.



Mobile pedestal with tambour door

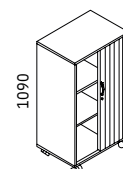

Pedestal with tambour door on feet

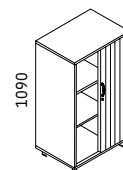

Add-on top

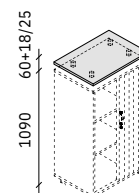

Inside drawer

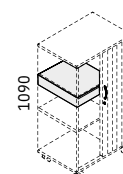
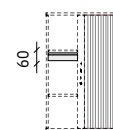

# Pedestals / Equipment

## Lock

Central lock with removable cylinder and two numbered keys, one foldable key as standard.

Possibility to choose identical lock as in the cabinets of your choice.

## Handles

TOP pedestals are equipped with handlebars. Pedestals with tambour doors and Cargo pedestals are equipped with B1 handles as standard. It is possible to change the handles.

SPACING : 128 mm

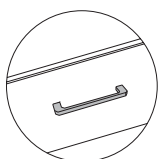

HANDLE A1



HANDLE B1

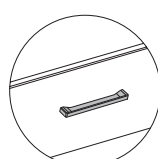

HANDLE C1

SPACING : 192 mm

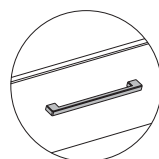

HANDLE Z1

SPACING : 64 mm

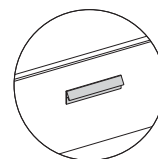

HANDLE V1

## Drawers

- Metal and composite black drawers, 500 mm or 700 mm long suitable for transverse, longitudinal and diagonal dividers.
- All drawers (except TOP Plus pencil drawer) are equipped with ball runners.
- Slides with soft close automatic mechanism are equipped with decelerating function and automatic self closing mechanism.
- Soft close automatic mechanism is equipped with cylindrical roller bearings and toothed belt. This helps stabilize the drawers when pulled out and loaded.
- 200 N. All drawers are equipped with a safety mechanism, preventing from simultaneous opening of more than one drawer.
- 1HE pencil drawers are equipped with 100% extension slide, 2 and 3HE drawers are equipped with 80% extension slide. Standard extension of 6HE drawers depends on the pedestal model (see information below). Max load: 200 N.
- 6HE pedestals with drawers are equipped with a file hanger insert as standard.

## Drawer accessories

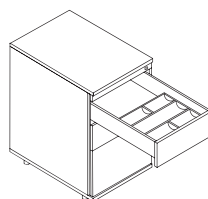

PENCIL TRAY DRAWER

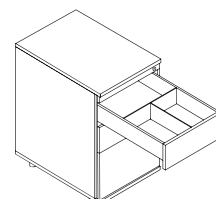

TRAVERSE AND LONGITUDINAL DIVIDERS

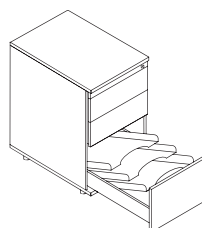

DIAGONAL DIVIDERS

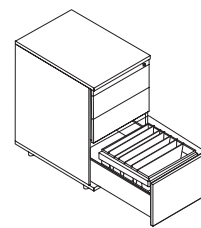

SUSPENSION FILES DRAWER

# Pedestals / Colours

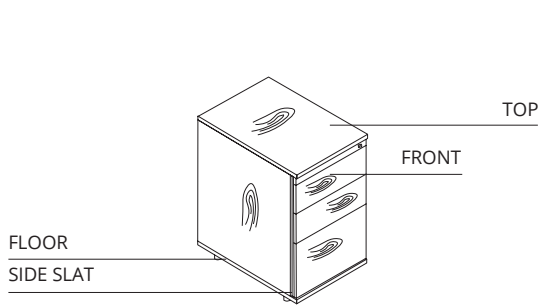

TOP pedestals

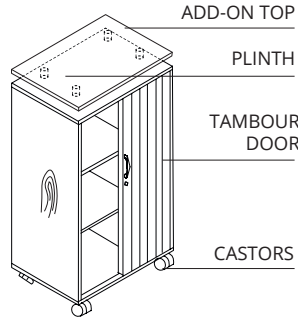

Pedestal with tambour door

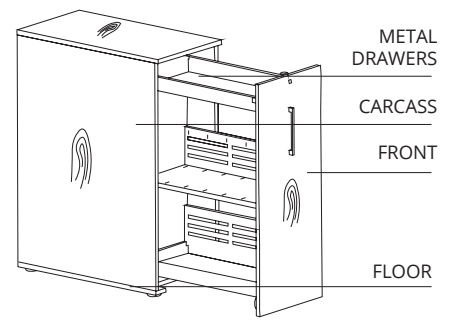

Cargo pedestals

			Carcass	Floor	Top	Metal drawers	Front	Add-on Top	Plinth	Tambour door	Side slat	Castors	
STANDARD	Melamine UNI	STD 1	White	•	•	•	•	•					
		STD 2	High Gloss										
		STD 3	White Gray	•	•	•	•	•					
		STD 4	Beige	•	•	•	•	•					
		STD 5	Norwegian	•	•	•	•	•					
		STD 6	Green Navy	•	•	•	•	•					
		STD 7	Blue	•	•	•	•	•					
		STD 8	Graphite Black	•	•	•	•	•					
	Melamine	STD 10	Acacia	•	•	•	•	•	•				
		STD 11	European Maple	•	•	•	•	•	•				
		STD 12	Napolitano Oak	•	•	•	•	•	•				
		STD 13	Gray Spruce	•	•	•	•	•	•				
		STD 14	American Oak	•	•	•	•	•	•				
		STD 15	Natural Oaky	•	•	•	•	•	•				
		STD 16	Cherry Havana	•	•	•	•	•	•				
		STD 17	Walnut Brown	•	•	•	•	•	•				
		TREND*	Melamine	TRD 1	Blush	•	•	•	•	•			
TRD 2	Claret			•	•	•	•	•					
TRD 3	Dark Turquoise			•	•	•	•	•					
TRD 11	Stark Oak			•	•	•	•	•					
TRD 12	Flamed Oak			•	•	•	•	•					
STANDARD	Metal	M 02	White						•				
		M 01	Aluminium						•				
		M 03	Beige						•				
		M 05	Graphite						•				
		M 04	Black				•		•				
TREND*	Metal	M 06	Sunny Beige						•				
		M 09	Dirty Pink						•				
		M 08	Ginger						•				
		M 07	Faded Turquoise						•				
STANDARD	ABS		Black								•	•	
		RL 01	White							•			
	Tambour doors	RL 02	Silver							•			
Metal		Black						•					

# Melamine

① STANDARD



② TREND

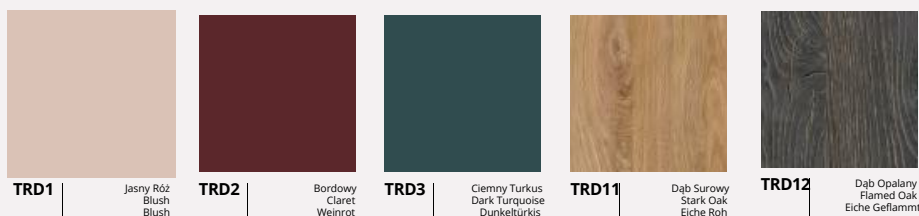

# Metals

① STANDARD

② TREND



# Fabrics

100% Polyester  
100.000 Martindale cycles

① CALDO  
Select by Lech

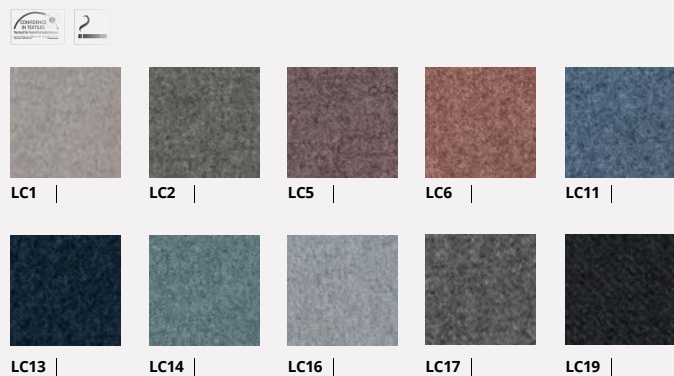

100 % Recycled Polyester  
67.000 Martindale cycles

① TERRA  
Select by Lech

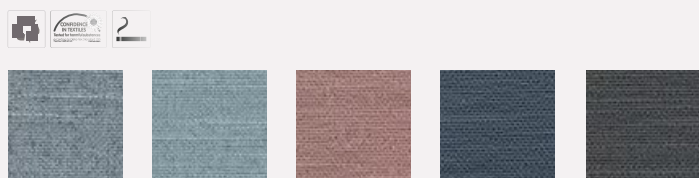

95% Virgin Wool, 5% Poliamid  
100.000 Martindale cycles

② SYNERGY  
Camira

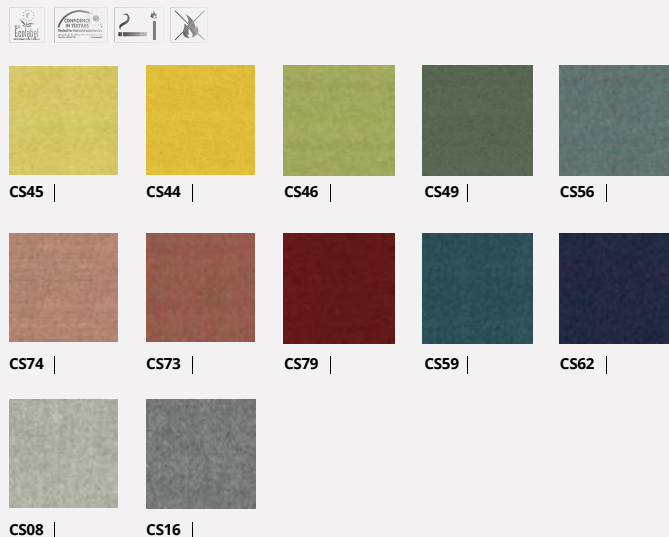

# aura design



Hub Spaces, 582 Honeypot Lane, Stanmore, HA7 1JS, UK  
[www.auraadesign.co.uk](http://www.auraadesign.co.uk)  
020 3915 8008  
[info@auraadesign.co.uk](mailto:info@auraadesign.co.uk)